



Installation,- Operating and Maintenance Instructions

HADEF Electric Chain Hoist

Type 66/04

stationary with suspension eye
with monorail push travel trolley
with monorail hand geared trolley
with monorail electric trolley

AKS
AKR
AKH
AKE



HADEF

 **NOTICE!**

The installation or mounting instructions for incomplete machines you'll find in chapter "Installation"

© by Heinrich de Fries GmbH

Heinrich de Fries GmbH, Gauss Str. 20, D-40235 Düsseldorf

Heinrich De Fries GmbH will be named HADEF in the following text.

Original operating- and maintenance instructions in German language.

Translation in other languages is made of the German original.

A copy may be requested in writing or is available for download on www.hadef.com

Subject to changes.

Table of Contents

1	Information	3
1.1	Indications to determine the used part of the theoretical usage life	4
2	Safety	4
2.1	Warning notice and symbols	4
2.2	Duty of care of the owner	4
2.3	Requirements for the operating personnel	5
2.4	Appropriate use	5
2.5	Basic safety measures	6
3	Transport and Storage	7
3.1	Transport	7
3.2	Safety device for transport	7
3.3	Storage	7
4	Description	7
4.1	Areas of application	7
4.2	Design	7
4.3	Functions	8
4.4	Important components	8
5	Technical data	10
6	Installation	13
6.1	Stationary hoist AKS + APS	13
6.2	Trolley	14
6.3	Assembly on the beam AK+AP 402 to AK+AP 912	15
6.4	Assembly on the beam AK+AP 915 - 930, AK+AP1010 - 1025	16
6.5	Tools	17
7	Operation	17
8	Operation	19
9	Commissioning	19
9.1	General	19
9.2	Power supply	19
9.3	Gear	20
9.4	Load chain	20
10	Safety check	20

11	Functional test	21
11.1	Checks before the initial start-up.....	21
11.2	Functional test.....	21
12	Maintenance	21
12.1	General.....	21
12.2	Monitoring.....	21
12.3	Replacing the load chain.....	21
12.4	Brake motor AK 4-8.....	23
12.5	Brake motor AK 9-10.....	23
12.6	Overload protection.....	23
13	Inspection	24
13.1	General Overhaul for motor-driven units.....	24
13.2	Periodic checks.....	24
13.3	Checking the load chain.....	25
13.4	Checking the load hook.....	25
13.5	Inspection – Gear – Oil level.....	26
14	Service	26
14.1	Load chain.....	26
14.2	Pulleys.....	27
14.3	Load hook.....	27
14.4	Hoist gear.....	27
14.5	Trolley.....	28
14.6	Electric motor.....	28
14.7	Lubricant selection.....	29
14.8	Lubricant for food industry – selection (as option*).....	29
15	Trouble	29
16	Remedy	30
17	Decommissioning	31
17.1	Temporary decommissioning.....	31
17.2	Final decommissioning/disposal.....	31
18	Additional documents	31
18.1	Electric wiring diagrams.....	31
18.2	Radio control (as option).....	31

1 Information

The products meet European Union requirements, in particular the validated EU Machine Directive.

The entire company works acc. to a certified quality assurance system as per ISO 9001.

The production of components at our work is subject to strict, intermediate checks.

After assembly, each product is subject to a final test with overload.

For the operation of hoists, the national accident prevention regulations apply in Germany, amongst others.

The stated performance of the devices and meeting any warranty claims require adherence to all instructions in this manual.

Before delivery, all products are packed properly. Check the goods after receipt for any damage caused during transport. Report any damage immediately to the forwarding agent.

This manual allows a safe and efficiently use of equipment. Images of this manual are for a principle understanding and can be different from the real design.

 **NOTICE!**

We refer to the prescribed equipment tests before initial start-up, before putting back into operation and the regular periodic inspections.

In other countries any additional national regulations must be observed.

1.1 Indications to determine the used part of the theoretical usage life.

For motor driven units.

The equipment (rope hoists, chain hoists, winches as well as crane hoisting units) are classified in drive groups (duty classification) according to their intended mode of operation, running times and load collectives and dimensioned according to the requirements derived from these.

They are thus only designed for a limited period of use with regard to the overall dimensioning and certification.

After the total period of use as elapsed, measures must be taken where parts are checked and exchanged as per indication by the manufacturer. After that a new maximum usage period is determined. See also the valued accident prevention regulations, "winches, lifting and pulling devices".

 **NOTICE!**



Commitment

A general overhaul may only be performed by HADEF or by a specialized company, authorized by HADEF.

2 Safety

2.1 Warning notice and symbols

Warnings and notice are shown as follows in these instructions:

 DANGER!	This means that there is a high risk that leads, if it is not avoided, to death or severe injury.
 WARNING!	This means that there is a risk that could lead, if it is not avoided, to death or severe injury.
 CAUTION!	This means that there is little risk that could lead, if it is not avoided, to slight injury or damage to the device or its surrounding.

 **NOTICE!** Gives advice for use and other useful information.

 Danger from electricity.

 Danger from explosive area.

2.2 Duty of care of the owner

 DANGER!
Failure to follow the instructions of this manual can lead to unpredictable hazards. For any resulting damage or personal injury, HADEF assumes no liability.

The unit was designed and built following a risk analysis and careful selection of the harmonized standards that are to be complied with, as well as other technical specifications. It therefore represents state-of-the-art technology and provides the highest degree of safety.

Our delivery includes the hoist supplied beginning at its suspension and ending at the load hook and if supplied with control, the control line/hose that leads to the hoist. Further operating material, tools, load attaching devices as well as main energy supply lines must be assembled according to the valid rules and regulations. For explosion-proof equipment, all these parts must be approved for use in area prone to explosion, or they must be suitable for use in area prone to explosion. The owner is responsible for this.

However, in everyday operation this degree of safety can only be achieved if all measures required are taken. It falls within the duty of care of the owner/user of the devices to plan these measures and to check that they are being complied with.

Complete the operating and installation instructions by any instructions (regarding supervision or notifications) that are important for the special kind of use of the equipment, i.e. regarding organization of work, work flow and human resources.

In particular, the owner/user must ensure that:

- The unit is only used appropriately.
- The device is only operated in a fault-free, fully functional condition, and the safety components, in particular, are checked regularly to ensure that it is functioning properly.
- The required personal protective equipment for the operators, service and repair personnel is available and is used.
- The operating instructions are always available at the location where the equipment is used and that they are legible and complete.
- The unit is only operated, serviced and repaired by qualified and authorized personnel.
- This personnel is regularly trained in all applicable matters regarding safety at work and environmental protection, and that they are familiar with the operating manual and, in particular, the safety instructions it contains.
- Any safety and warning signs on the devices are not removed and remain legible.
- Devices for use in area prone to explosion must (from customer's side) be earthed with a shunting resistor of $< 10^6 \Omega$ against earth.



WARNING!

It is not allowed to make constructive changes of the equipment!

2.3 Requirements for the operating personnel

The units may only be operated by qualified persons that are appropriately trained and that are familiar with it. They must have their employer's authorisation for operation of the units.

Before starting work, the operating personnel must have read the operating and installation instructions, especially the chapter "Safety Instructions".

This is especially important for operating personnel that rarely uses the equipment, i.e. for installation or maintenance work.



DANGER!

In order to avoid severe injury, please pay attention to the following when using the equipment:

- Use protective clothes/equipment.
- Do not wear long hair hanging down open.
- Do not wear rings or other jewellery.
- Do not wear clothes that are too big/wide.

2.4 Appropriate use

The permitted safe working load of the devices must not be exceeded! An exception can be made during the load test before initial operation, carried out by a licensed qualified person.

- The permissible ambient temperature during operation of manual driven devices is $-20^{\circ} \text{C} / +50^{\circ} \text{C}$ and at all power driven devices $-20^{\circ} \text{C} / +40^{\circ} \text{C}$!
- Defective devices and load suspension devices must not be used until they have been repaired! Only original spare parts must be used. Non-compliance will result in any warranty claims becoming void.
- Liability and warranty will become void if unauthorized modifications of the units are made by the user!

The appropriate use of the hoists is vertical lifting and lowering of unguided loads. In combination with trolleys, loads can also be moved horizontally.



DANGER!

It is not allowed:

- pulling loose of stuck loads, dragging of loads and inclined pulling is not allowed.
- in explosive atmosphere, except the unit is especially modified for it and marked by an indication label
- to transport people
- The device is not suitable for use on stages and in studios
- persons must not stand under a suspended load



NOTICE!

If the units are not used appropriately, it is not possible to ensure safe operation.

The owner and operator have sole liability for all personal injury and damage to property arising from inappropriate use.

2.5 Basic safety measures

- Observe installation-, operation and maintenance instruction.
- Take notice of caution notes at units and in the manual
- Observe safety distances.
- Take care for a free view on the load.
- Only use the hoists appropriately.
- The equipment is to be used exclusively for movement of goods. Under no circumstances may persons be moved.
- Never load the devices beyond their working load limit.
- Pay attention to the accident prevention regulations (UVV).
- Should the hoist be used outside of Germany, please pay attention to the national regulations that apply.
- Supporting structures and load-attached devices used in conjunction with this equipment must provide an adequate safety factor to handle the rated load plus the weight of the equipment. In case of doubt, consult a structural engineer.
- If the equipment has not been used for a period of time, carry out visual checks of all main components such as chains, load hooks etc. and replace any damaged parts with new, original spare parts before putting the equipment back into operation!
- Do not use a hoist that is defective, pay attention to any abnormal noise it makes during operation.
- Stop working immediately in case of disturbances and remedy failures.
- Any damage and faults must be reported to a responsible supervisor immediately.
- If the unit is put into motion, any persons in the immediate vicinity must be informed by calling to them!
- Please pay attention to the regulations for load carrying devices UVV for both positive and non-positive methods of attaching loads.
- The lifting tackle or the load must be securely attached to the hook and be seated at the bottom of the hook.
- The safety catch of hooks must be closed.
- When charged, the housing may not be in contact somewhere.
- Stop lowering the load when the bottom block or the load is being set down or is prevented from being lowered further.
- The load chain must not be twisted.
- Twisted chains must be aligned before attaching the load.
- The correct alignment of the chain links can be seen from the weld seams.
- The chain links must always be aligned in one direction.
- Check brakes daily before commencing work.
- The devices are not suitable for continuous operation. The duty cycles of the motors (see the technical data chapter) as well as the remaining life time of the equipment in accordance with FEM group and usage (see calculation of remaining safe working period) must be observed.

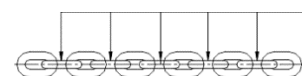

Illustration 1

 **WARNING!**

The following is not allowed:

- to lift another load than the nominal safe working load
- to manipulate the sliding clutch if units are equipped with
- The use of elongated or damaged chains or wire ropes. Replace them immediately by new, original parts.
- Never loop the load chain around a load nor place or pull the chain over edges.
- Never repair damaged load hooks (e.g. by hammering), but replace them by original hooks.

3 Transport and Storage

 **CAUTION!**

Transport may only be done by qualified personnel. No liability for any damage resulting from improper transport or improper storage.

3.1 Transport

The devices are checked and if so adequately packed before delivery.

- Do not throw or drop the equipment.
- Use adequate means of transport.

Transport and means of transport must be suitable for the local conditions.

3.2 Safety device for transport

 **NOTICE!**

Should a safety device for transport exist, please remove it before commissioning.

3.3 Storage

- Store the equipment at a clean and dry place.
- Protect the equipment against dirt, humidity and damage by an appropriate cover.
- Protect hooks, wire ropes, chains and brakes against corrosion.

4 Description

4.1 Areas of application

The devices must be as far as possible installed in a covered room.

If they are used in the open, protect the units against the effects of weather such as rain, hail, snow, direct sunshine, dust, etc. - we recommend to use a cover in parking position. If the device is set up in a continuously humid environment with strong temperature fluctuations, the correct functionings are endangered by the forming of condensation.

Ambient temperature -20°C up to +50°C. Power-operated units -20 up to +40°C. Humidity 100 % or less but not under water

During longer periods of standstill, corrosion may reduce the function of the brake.

  **DANGER!**

It is not permitted to use the unit in an area at risk from explosion!

4.2 Design

HADEF electrical chain hoists are equipped with a suspension eye for stationary use. The one and two chain fall devices may optionally be equipped with a suspension hook.

All devices can also be supplied with monorail trolley with push travel, hand geared or electric drive.



Type 66/04 AKS - stationary

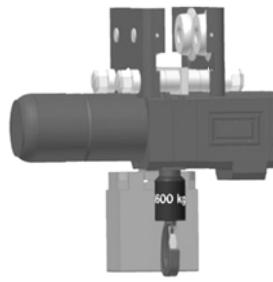

Type 66/04 AKR - with push travel trolley

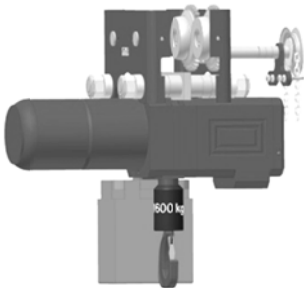

Type 66/04 AKH with hand geared trolley

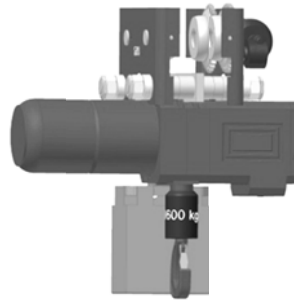

Type 66/04 AKE with electric trolley

Operational limit switches for lifting and lowering as standard for all hoists AK4–AK10 with contactor control. Frequency converter control as standard for trolley for AK10.

4.3 Functions

The lifting gear and motor-driven trolley are moved by pressing the buttons on the control switch. The spring-pressure brake installed in the electric motor of the lifting gear prevents the independent lowering of the load after the push button has been released.

By using a frequency converter, the speed is infinitely variable.

Hand geared trolleys are moved to the left or right by pulling one of the two stands of the endless hand chain.

In combination with push travel trolleys the trolley is moved by pushing or pulling the load or, without load, by pulling the load chain.

NOTICE!

The best protection against functional failures in case of extreme environmental impact is the regular use of the equipment.

If the hoist is not used very often, we recommend to carry out a test run at least once a week and to switch on the motor several times during this test run.

In our experience, this will prevent the brake from sticking.

4.4 Important components

NOTICE!

All hoists are fitted with high-quality lifting gears of the reliable AK series.

4.4.1 Motor

	Type of chain hoist
Electric motor	66/04 AK
	28/06E
	29/06E, 29/06EEL Big Bag, 29/06E-Synchro
	90/09EX, 91/09EX

4.4.2 Gear

Lifting gear with ventilation screw

AK 4-8 Precision Spur Gear

AK9+10 Precision Planetary Gear

Trolley gear

Combination of worm gear and motor

Closed design - ventilation not necessary.

4.4.3 Control

Control switch with emergency stop

Classification of control according to lifting gear sizes

Kind of control	Serial	Option
Direct control	AK 4-7	
low voltage control	AK8-10; AK6-8 Ex-version	AK 4-7
Radio control		AK4-10; AK6-8 Ex-version
Frequency control		AK4-10; AK6-8 Ex-version

4.4.4 Overload protection

Type	Slipping clutch	electric limit switch		mechanical stop by spring assembly	
		Serial	Option	Serial	Option
66/04 AK, 90/09EX	AK4-8		AK4-10	AK9+10	
28/06E	AK4-8		AK4-10		AK4-8
29/06E, 91/09EX	AK4-8	AK9+10	AK4-8		AK4-10
29/06E-Synchro	AK 4-7		AK 4-7		
29/06EEL Big Bag	AK 4-7		AK 4-7		AK 4-7

4.4.5 Load chain

acc. to EN 818-7-T high quality chain

4.4.6 Load hook

Hook in ball bearing with safety catch.

4.4.7 Chain container

According to hoist type made of coated fabric, plastic or of steel plate.

4.4.8 Rotation direction/ Phase sequence relay

Protection against wrong net connection

(only with low voltage control)

4.4.9 Thermal detector

to protect the hoist motor

(only with low voltage control)

4.4.10 Safety limit switch (lifting/lowering)

automatic stop when the load chain does not run correctly

(only applicable for hoists with tensioning device)

4.4.11 Operation limit switch

operational driving into upper and lower hook position

(optional for direct control)

4.4.12 Special components

only for hoists that are used in area at risk of explosion

5 Technical data

Table 1

Capacity/ chain falls kg	Type	lifting speed m/min	duty classi- fication FEM 9.511/ ISO 4301	motor output kW	operation time ED %	current consump- tion A	cos phi	noise emission at 1m distance tolerance +2 dB(A) dB(A)	weight at 3m suspension, or track height kg				weight per m add. lift kg
									S	R	H	E	
250/1	AK 402 DT 80 N 8/2	14/3,5	3m/ M6	0,75/0,18	40/25	2,4/1,1	0,76/0,58	60	65	77	79	91	0,8
500/1	AK 405 DT 80 K4	6	3m/ M6	0,63	100	1,85	0,70	56	65	77	79	91	0,8
500/1	AK 405 DT 80 N 8/2	9/2,2	3m/ M6	0,75/0,18	40/25	2,4/1,1	0,76/0,58	60	65	77	79	91	0,8
630/1	AK 406 DT 80 K4	6	3m/ M6	0,63	60	2,1	0,73	56	65	77	79	91	0,8
630/1	AK 406 DT 80 N 8/2	9/2,2	3m/ M6	1/0,25	25/15	2,6/1,4	0,76/0,58	60	65	77	79	91	0,8
1000/2	AK 410 DT 80 K4	3	3m/ M6	0,63	100	1,85	0,70	56	75	87	89	101	1,4
1000/2	AK 410 DT 80 N 8/2	4,5/1,1	3m/ M6	0,75/0,18	40/25	2,4/1,1	0,76/0,58	60	75	87	89	101	1,4
1000/1	AK 610 DT 90 L	8/2	3m/ M6	1,5/0,37	30/20	4,1/2,1	0,9/0,67	67	100	124	126	141	1,3
1250/2	AK 412 DT 80 N 8/2	4,5/1,1	3m/ M6	1/0,25	25/15	2,6/1,4	0,76/0,58	60	75	87	89	101	1,4
1250/1	AK 612 DT 90 L 8/2	8/2	3m/ M6	1,8/0,44	25/15	4,4/2,1	0,9/0,67	67	100	124	126	141	1,3
1600/1	AK 716 DT 100 L 8/2	8/2	3m/ M6	2,1/0,55	40/40	4,6/2,1	0,88/0,68	70	125	164	167	181	2,1
1600/1	AK 716 DT 100 L 8/2	11/2,6	3m/ M6	3,2/0,8	30/20	6,4/2,7	0,88/0,68	70	130	164	167	181	2,1
2000/2	AK 620 DT 90 L 8/2	4/1	3m/ M6	1,5/0,37	30/20	4,1/2,0	0,9/0,67	70	105	128	131	146	2,5
2000/1	AK 820 FN 100 M 8/2	10/2,5	3m/ M6	4/1,1	40/25	10/6	0,85/0,64	70	130	168	172	186	3,1
2500/2	AK 625 DT 90 L 8/2	4/1	3m/ M6	1,8/0,44	25/15	4,4/2,1	0,9/0,67	70	105	128	131	146	2,5
2500/2	AK 725 DT 100 L 8/2	5,5/1,3	3m/ M6	2,6/0,65	40/25	5,4/2,5	0,88/0,68	70	130	168	172	186	3,9
2500/1	AK 825 FN 100 M 8/2	8/2	3m/ M6	4/1,1	40/25	10/6	0,85/0,64	70	130	168	172	186	3,1
3200/2	AK 732 DT 100 L 8/2	4/1	3m/ M6	2,1/0,55	40/40	5/2,3	0,88/0,68	70	130	168	172	186	3,9
3200/2	AK 832 FN 100 M 8/2	5/1,25	3m/ M6	4/1,1	40/25	10/6	0,85/0,64	70	135	168	172	191	5,6
4000/2	AK 840 FN 100 M 8/2	5/1,25	3m/ M6	4/1,1	40/25	10/6	0,85/0,64	70	135	168	172	191	5,6
5000/2	AK 850 FN 100 M 8/2	4/1	3m/ M6	4/1,1	40/25	10/6	0,85/0,64	70	135	173	177	203	5,6

Table 2

Capacity/ chain falls kg	Type	lifting speed m/min	duty classi- fication FEM 9.511/ ISO 4301	motor output kW	operation time ED %	current consump- tion A	cos phi	noise emission at 1m distance tolerance +2 dB(A) dB(A)	weight at 3m suspension, or track height kg				weight per m add. lift kg
									S	R	H	E	
5000/1	AK 905 FN 112 M 8/2	5,4/1,35	3m/ M6	5,5/1,4	40/25	12,5/6,4	0,82/0,62	75	260	340	345	358	6
5000/1	AK 905 FN 132 M 8/2	8/2	3m/ M6	8,5/2	40/25	18,2/6,5	0,89/0,67	75	270	350	355	368	6
6300/1	AK 906 FN 112 M 8/2	5,4/1,35	3m/ M6	6/1,5	30/20	13,8/7	0,84/0,64	75	260	340	345	358	6
6300/1	AK 906 FN 132 M 8/2	8/2	3m/ M6	8,5/2	40/25	18,2/6,5	0,89/0,67	75	270	350	355	368	6
10000/2	AK 910 FN 112 M 8/2	2,8/0,7	3m/ M6	5,5/1,4	40/25	12,5/6,4	0,82/0,62	75	350	432	437	450	11,7
10000/2	AK 910 FN 132 M 8/2	4/1	3m/ M6	8,5/2	40/25	18,2/6,5	0,89/0,67	75	360	442	447	460	11,7
10000/1	AK 1010 FN 160 M 8/2	5,8/1,4	3m/ M6	12/2,5	40/25	28/9	0,85/0,60	*)		*)	*)	*)	*)
12000/2	AK 912 FN112 M 8/2	2,8/0,7	3m/ M6	6/1,5	30/20	13,8/7	0,84/0,64	75	350	432	437	450	11,7
12000/2	AK 912 FN 132 M 8/2	4/1	3m/ M6	8,5/2	40/25	18,2/6,5	0,89/0,67	75	360	442	447	460	11,7
12500/1	AK 1012 FN 160 M 8/2	5,8/1,4	3m/ M6	12/2,5	40/25	28/9	0,85/0,60	*)		*)	*)	*)	*)
15000/3	AK 915 FN 112 M 8/2	1,8/0,45	3m/ M6	5,5/1,4	40/25	12,5/6,4	0,82/0,62	75	450	824	830	850	17,4
15000/3	AK 915 FN 132 M 8/2	2,6/0,6	3m/ M6	8,5/2	40/25	18,2/6,5	0,89/0,67	75	460	834	840	860	17,4
20000/4	AK 920 FN 112 M 8/2	1,35/0,35	3m/ M6	5,5/1,4	40/25	12,5/6,4	0,82/0,62	75	565	1008	1015	1040	23,1
20000/4	AK 920 FN 132 M 8/2	2/0,5	3m/ M6	8,5/2	40/25	18,2/6,5	0,89/0,67	75	575	1018	1025	1050	23,1
20000/2	AK 1020 FN 160 M 8/2	2,9/0,7	3m/ M6	12/2,5	40/25	28/9	0,85/0,60	*)		*)	*)	*)	*)
25000/5	AK 925 FN 112 M 8/2	1,1/0,27	3m/ M6	5,5/1,4	40/25	12,5/6,4	0,82/0,62	75	605	1127	1135	1165	28,8
25000/5	AK 925 FN 132 M 8/2	1,6/0,4	3m/ M6	8,5/2	40/25	18,2/6,5	0,89/0,67	75	615	1137	1145	1175	28,8
25000/2	AK 1025 FN 160 M 8/2	2,9/0,7	3m/ M6	12/2,5	40/25	28/9	0,85/0,60	*)		*)	*)	*)	*)
30000/6	AK 930 FN 112 M 8/2	1/0,2	3m/ M6	5,5/1,4	40/25	12,5/6,4	0,82/0,62	75	665	*)	*)	*)	32,5
30000/6	AK 930 FN 132 M 8/2	1,3/0,3	3m/ M6	8,5/2	40/25	18,2/6,5	0,89/0,67	75	675	*)	*)	*)	32,5
30000/3													
35000/3													

Table 2 continuation

Capacity/ chain falls kg	Type	lifting speed m/min	duty classi- fication FEM 9.511/ ISO 4301	motor output kW	operation time ED %	current consump- tion A	cos phi	noise emission at 1m distance tolerance +2 dB(A) dB(A)	weight at 3m suspension, or track height kg				weight per m add. lift kg
									S	R	H	E	
40000/4													
45000/4													
50000/4													
60000/2x3													
65000/2x3													
70000/2x3													
75000/2x4													
80000/2x4													
85000/2x4													
90000/2x4													
100000/2x4													

*) This information was not available at the printing deadline.

HADEF chain hoists AK+AP 4-10 are fitted with high-quality load chains. These chains meet all technical requirements as per EN 818-7-T.

Type AK+AP	chain
4	5 x 15
6	7 x 21
7	9 x 27
8	11,3 x 31
9	16 x 45
10	23,5x66

Trolleys

capa- city kg	hoisting unit Type	Trolley Type	Trolley Type	hand chain hoist approx. daN	Trolley Type	travel speed m/min	travel motor output kW	travel speed m/min	travel motor output kW	max. wheel pres- sure daN **)	setting range for beam flange width from - to	
											Load bolt 1N mm	Load bolt 2N mm
250/1	AK 402...	AFR 10	AFH 10	4	AFE 10	16/4	0,25/ 0,06	30/7,5	0,50/ 0,12	150	50-135	136-220
500/1	AK 405...	AFR 10	AFH 10	4	AFE 10					150	50-135	136-220
630/1	AK 406...	AFR 10	AFH 10	6	AFE 10					192	50-135	136-220
1000/2	AK 410...	AFR 10	AFH 10	8	AFE 10					257	50-135	136-220
1000/1	AK 610...	AFR 20	AFH 20	6,5	AFE 20					387	66-185	186-310
1250/2	AK 412...	AFR 10	AFH 10	10,5	AFE 10					374	50-135	136-220
1250/1	AK 612...	AFR 20	AFH 20	8,5	AFE 20					397	66-185	186-310
1600/1	AK 716...	AFR 32	AFH 32	6	AFE 32					501	74-196	197-310
2000/2	AK 620...	AFR 20	AFH 20	12,5	AFE 20					510	66-185	186-310
2000/1	AK 820...	AFR 32	AFH 32	8	AFE 32					622	74-196	197-310
2500/2	AK 625...	AFR 20	AFH 20	9,5	AFE 20					639	66-185	186-310
2500/2	AK 725...	AFR 32	AFH 32	9,5	AFE 32					639	74-196	197-310
2500/1	AK 825...	AFR 32	AFH 32	9,5	AFE 32					639	74-196	197-310
3200/2	AK 732...	AFR 32	AFH 32	12	AFE 32					764	74-196	197-310
3200/2	AK 832...	AFR 32	AFH 32	12	AFE 32					1220	74-196	197-310
4000/2	AK 840...	AFR 32	AFH32	12	AFE32					1486	74-196	197-310
5000/2	AK 850...	AFR 50	AFH 50	12	AFE 50	1520	74-192	193-310				
5000/1	AK 905...	-	AFH 50	7	AFE 50	2100	119-215	216-312				
6300/1	AK 906...	-	AFH 50	9	AFE 50	2615	119-215	216-312				
10000/2	AK 910...	-	AFH 100	14	AFE 100	3520	119-215	216-312				

Trolleys

capacity kg	hoisting unit Type	Trolley Type	Trolley Type	hand chain hoist approx. daN	Trolley Type	travel speed m/min	travel motor output kW	travel speed m/min	travel motor output kW	max. wheel pres- sure daN **)	setting range for beam flange width from - to	
											Load bolt 1N mm	Load bolt 2N mm
10000/1	AK 1010...	-	1xAFH 50 1xAFR 50	17	2xAFE 50	0...16	2x0,55 FU			*)	119-215	216-312
12000/2	AK 912...	-	AFH 100	17	AFE 100	16/4	0.42/ 0.10			4200	119-215	216-312
12500/1	AK 1012...	-	1xAFH 50 1xAFR 50	19	2xAFE 50	0...16	2x0,55 FU			*)	119-215	216-312
15000/3	AK 915...	-	AFH 200	20	AFE 200	16/4	2x 0,55/0,14			4970	131-221	222-310
20000/4	AK 920...	-	AFH 200	22	AFE 200	16/4	2x 0,75/0,18			6785	160-310	-
20000/2	AK 1020...	-	1xAFH100 1xAFR100	25	2xAFE100	0...16	2x0,75 FU			*)	119-215	-
25000/5	AK 925...	-	AFH 250	27	AFE 250	16/4	2x 1/0,25			7800	160-310	-
25000/2	AK 1025...	-	1xAFH200 1xAFR200	29	2xAFE200	0...16	2x1 FU			*)	160-310	-
30000/6	AK 930...	-	*)	*)	*)	*)	*)			*)	160-310	-
30000/3	AK 1030...											
35000/3	AK 1035...											

Trolleys

capacity kg	hoisting unit Type	Trolley Type	Trolley Type	hand chain hoist approx. daN	Trolley Type	travel speed m/min	travel motor output kW	travel speed m/min	travel motor output kW	max. wheel pres- sure daN **)	setting range for beam flange width from - to	
											Load bolt 1N mm	Load bolt 2N mm
40000/4	AK 1040...											
45000/4	AK 1045...											
50000/4	AK 1050...											
60000/2x3	AK 1060...											
65000/2x3	AK 1065...											
70000/2x3	AK 1070...											
75000/2x4	AK 1075...											
80000/2x4	AK 1080...											
90000/2x4	AK 1090...											
100000/2x4	AK 10100...											

*) This information was not available by the print deadline **) Wheel pressure including the weight of the hoisting device and trolley at nominal load and 3 m suspension height.

3-phase current motor 400V/50Hz - IP55 – F – max. 1000 m above sea level.

Order-related Special data, refer to the motor nameplate.

6 Installation

6.1 Stationary hoist AKS + APS

Stationary designs are supplied with a suspension eye. A suspension hook is available as option.

They are usually supplied assembled in full. In exceptional circumstances, the suspension eye/ suspension hook is not assembled.

If a change is made from a one to a two chain fall design the suspension eye or the suspension hook must be adjusted.



WARNING!

The hoist must always hang centrally under the beam or under its suspension point.

AK+AP 4-8, single and double chain falls

For single or double chain falls, the suspension eye (1) or the suspension hook must be connected to the two or three holes of the housing (2) so that the load is placed centrally under the suspension point.

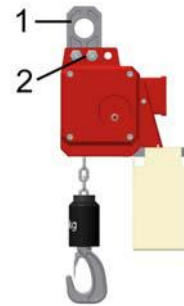

Illustration 2

AK+AP 4-8, modification from single chain fall to double chain falls

In case of modification from single to double chain falls or vice versa, it is important that the suspension eye (1) or the suspension hook is moved to a position so that the load hangs centrally again.

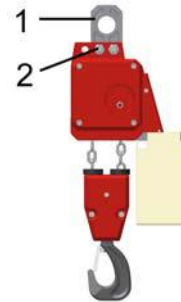

Illustration 3

AK+AP 9-10, single and several chain falls

The stationary type with suspension eye can optionally also be supplied with suspension hook. As standard they are supplied assembled in full.

The hoist with suspension eye (1) is fitted with two holes. Assemble the suspension eye (1) between the two brackets (2).

Insert the bolt.

In order to avoid confusion of the holes, they have different sizes.

The larger hole must take the entire load and part of the proper weight of the hoist. The smaller hole must take the remaining weight. The bolts must be chosen according to their loading.

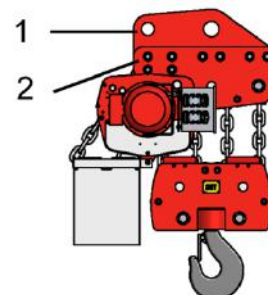



Illustration 4

 **CAUTION!**
If this is not observed it may damage the chain feed-in.

The assembly and installation depends on the local environment. The hoist must be suspended in a way that it can position itself freely.

6.2 Trolley

For assembly on a beam a travel limit must be placed at either end of the track.

This must be attached so that any elastic limitation buffer or the trolley wheels are driven against them in their end position when moving.

Generally, additional lifting gear (e.g. fork lift, lifting platforms) will be required for the assembly. These must take the weight of the devices securely.

6.3 Assembly on the beam AK+AP 402 to AK+AP 912

6.3.1 Outline:

- Side plate (1)
- load bolt (2)
- hexagon nuts (3)
- safety nuts (4)
- distance tubes (5)
- washers (6)
- traverse (7)
- beam width (B)
- gauge (X)

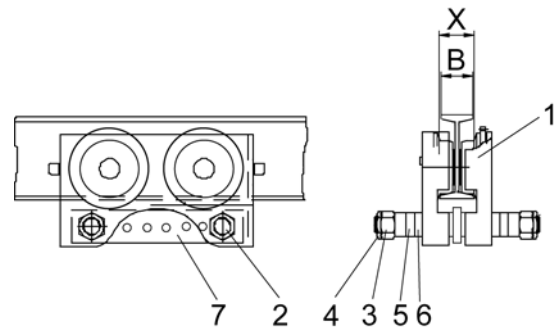



Illustration 5

6.3.2 Procedure

- 1 Pre-assemble the side plates (1) to fit the gauge "X".
- 2 Push on the unit at the face of the beam flange.

If this is not possible for lack of space or fixed end stops the trolley can also be installed on the beam from below.

- 1 Unscrew the hexagon nut (3) and safety nuts (4) at one side and pull apart the side plates (1) as far until it is possible to push the trolley onto the beam flange from below.
- 2 Push the trolley together again until it reaches the correct wheel gauge (X).
- 3 Secure the washers (6) and distance tubes (5) by tightening the hexagon nuts (3) and the safety nuts (4).
- 4 Make sure the washers (6) and distance tubes (5) are placed symmetrically.

 **WARNING!**
The hoist must always hang centrally under the beam or under its suspension point.

 **CAUTION!**
The distance "X" between the wheel flanges of the trolley wheels must exceed the flange width "B" of the beam by 2-3 mm (1-1,5 mm each side).

Traverse for trolley installation for chain hoists with 1-and 2-falls
AK7+AK8

Dimensions mm	AK+AP 402+405	AK+AP 410	AK+AP 610	AK+AP 620	AK+AP 716	AK+AP 732	AK+AP 820	AK+AP 832+840	AK+AP 850
D	21	21	31	31	37	37	37	37	40
H1	332	397	418	520	494	634	496	586	592
H2	50	50	65	65	75	75	100	100	100
M	M 12	M 12	M 16	M 16	M 20	M 20	M 24	M 24	M 24
L	215	215	245	245	290	290	380	380	454
L1	82,7	107,5	87,25	122,25	101,25	144,75	190	190	227
L2	24,6	24,6	34,5	34,5	43,5	43,5	50,3	50,3	50,3
S	15	15	15	15	20	20	20	20	20

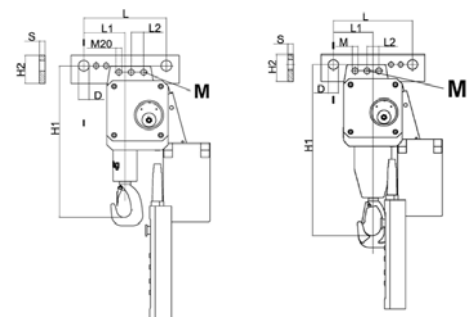

Illustration 6

6.4 Assembly on the beam AK+AP 915 - 930, AK+AP1010 - 1025

6.4.1 Outline:

- side plates (1)
- load bars (2)
- washers (3)
- traverse (4)
- safety rings (5)
- hexagon screws (6)
- safety nuts (7)
- serrated lock washer (8)
- beam flange width (B)
- gauge (X)

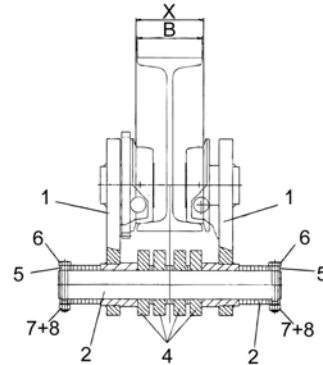



Illustration 7

6.4.2 Procedure

- 1 Pre-assemble the side plates (1) to fit the gauge "X".
- 2 Push on the unit at the face of the beam flange.

If this is not possible for lack of space or fixed end stops the trolley can also be installed on the beam from below.

- 1 Remove the safety rings (5) and safety screws (6) at one side.
- 2 Pull apart the side plates (1) as far until it is possible to push the trolley onto the beam flange from below.
- 3 Push the trolley together again until it reaches the correct wheel gauge (X).
- 4 Place the washers (3) again.
- 5 Make sure the washers (3) are placed symmetrically.
- 6 Secure the hexagon screws (6) with serrated lock washers (8) and safety nuts (7).
- 7 Place the safety ring (5) again.

 **WARNING!**
The hoist must always hang centrally under the beam or under its suspension point.

 **CAUTION!**
The distance "X" between the wheel flanges of the trolley wheels must exceed the flange width "B" of the beam by 3-5 mm (1,5-2,5 mm each side) .

dimensions mm	AK+AP	AK+AP	AK+AP	AK+AP	AK+AP	AK+AP	AK+AP	AK+AP
	905	906	910	912	915	920	925	930
A	635	635	635	635	720	850	980	1440
A1	412	412	486	486	553	630	705	940
A2	72	72	146	146	217	290	370	435
B1	105	105	80	80	80	80	80	80
B2	139	139	104	104	107	107	107	145
C	70	70	148	148	157	168	179	205
C1	50	50	53	53	60	80	90	80
C2	55	55	65	65	65	90	100	110
D	52	52	61	61	61	71	76	80
D1	33	33	41	41	41	61	61	61

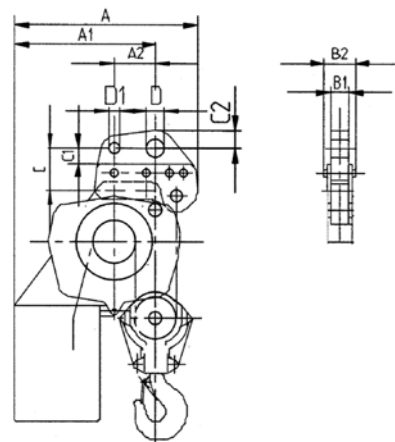

Illustration 8

dimensions mm	AK+AP1010 AK+AP1012	AK+AP1020 AK+AP1025
A	660	774
A2	107	214
B1	80	80
B2	222	222
C1	4205	80
C2	65	110
D	50	76,5
D1	50	61,5

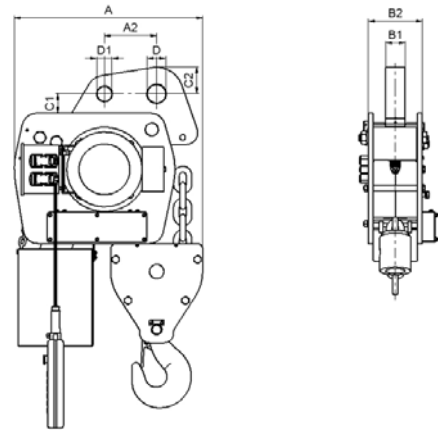
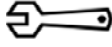
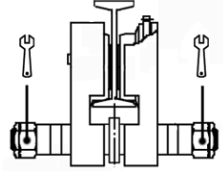
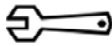
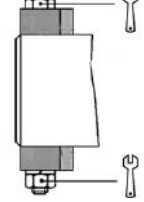
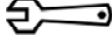
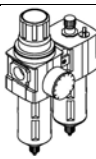

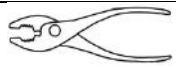
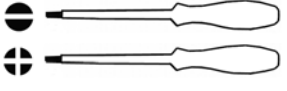



Illustration 9

6.5 Tools

Capacity	Size	Tool	Use	
0,5t 1t 1,5t + 2t 2,5t + 3,2t + 4,0t 5t + 6,3t 7,5t + 10t	SW27 SW36 SW46 SW55 SW60 SW75		Load bar	
12,5t 16t – 60t	SW22 SW24		Load bar with fixing ring	
only if pneumatic drive exist	div.		Pneumatic connections	
			div.	
			div.	
	div.		Electric div.	

7 Operation

Only people that are familiar with the operation of the lifting devices and cranes may be entrusted with their operation. They must be authorized by the employer for the operation of the equipment. The employer must ensure that the operating instructions are available near the equipment and that they are accessible for the operating personnel.

The shown control switches are only for the optical information. They can be different acc. the delivery.

Pendant control lifting/lowering direct control

- 1 Emergency-Stop
- 2 Lifting (slow - fast)
- 3 Lowering (slow - fast)



Illustration 10

Pendant control – 4 push buttons

- 1 Emergency stop
- 2 Selection switch (as option)
- 3 Lifting (slow - fast)
- 4 Lowering (slow - fast)
- 5 Trolley travel right side (slow - fast)
- 6 Trolley travel left side (slow - fast)

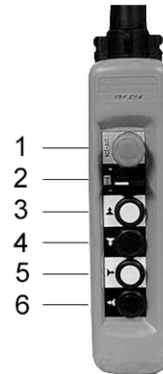

Illustration 11

Radio control

- 1 Lowering (slow - fast)
- 2 Lifting (slow - fast)
- 3 Trolley travel left side (slow - fast)
- 4 Trolley travel right side (slow - fast)
- 5 Crane travel south (slow - fast)
- 6 Crane travel north (slow - fast)
- 7 no function
- 8 no function
- 9 start
- 10 start
- 11 emergency stop



Illustration 12

Push button functions

Relieved push button = stand still
 push button half pushed = slow speed
 push button pushed completely = fast speed

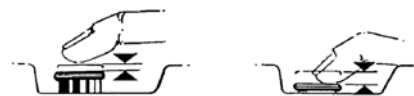

Illustration 13

Red Emergency-Stop button

button pushed = stand still
 turn the button clockwise = free functions



Illustration 14

8 Operation

The following, important points must be observed when operating the equipment:

- Read the safety instructions.
- Never load the devices beyond their working load limit.
- When changing the motor turning direction, allow the motor to come to a standstill first.
- The prescribed maintenance intervals must be adhered to.
- Observe the duty cycle, i.e. intermittent operation S4-40% ED (as per VDE 0530) means that in a period of 10 minutes the motor can operate – no matter the height of the load – for 4 minutes. It is therefore irrelevant whether the 4 minutes are continuous (i.e., in case of very high lifting heights) or are made in intervals.
- The lifting tackle or the load must be securely attached to the hook and be seated at the bottom of the hook. The safety catch must always be closed.

 **DANGER!**

It is not allowed:

- pulling loose of stuck loads, dragging of loads and inclined pulling is not allowed.
- in explosive atmosphere, except the unit is especially modified for it and marked by an indication label
- to transport people
- The device is not suitable for use on stages and in studios
- persons must not stand under a suspended load

9 Commissioning

9.1 General

Should the unit be used in Germany:

Please observe the validated, national accident prevention regulations.

For other countries:

Inspections as above. Please observe the national rules and regulations and the instructions in this manual!

NOTICE!

Hoists up to 1000 kg capacity and without motor-driven trolleys of hoisting unit must be tested by a “qualified person” before putting into operation for the first time.

Hoists of 1000 kg capacity and up or with more than one motor-driven hoist movement; i.e. lifting and trolley movement, must be tested by a “licensed qualified person” before putting in operation.

An exception is “hoists ready for operation” acc. validated national regulations with EU-declaration of conformity.

Definition “qualified person” (former expert)

A “qualified person” has learned, due to occupational training and experience and the job that the person has done, the skills needed to tests the material for one’s work.

Definition “licensed qualified person” (former approved expert)

A “licensed qualified person” has, due through special occupational training, knowledge about testing of the material for one’s work and knows the national accident prevention regulations and other prescriptions and technical regulations. This person must test the material for one’s work regularly with regard to design and kind of use. The license will be given to qualified person be the approved supervision authorities (ZÜS).

9.2 Power supply

9.2.1 Mains connection

Hoist motor technical data can be found it in the "Technical data" chapter.

The following tables show the assignment of the fuses at 400 Volt 3-phase current.

- Select connection cross-sections as per VDE 0100.
- Put sleeves on the ends of the cables.

- Insert the connection cable into the connection plug without strain.
- Secure lines as per VDE 0100.

9.2.2 Control line connection

Pendant with cable and plug-in connection. Plug-in before use.

Any changes of the power supply cable must only be effected by qualified personnel.

9.2.3 Power connection of the brake

The low-maintenance D.C. spring-pressure brakes are connected at the factory according to the wiring diagram.

9.2.4 Wiring diagram

Wiring diagrams are situated in the terminal box or can be requested from HADEF by mentioning of serial number.

9.2.5 Assigning of line cross-sections and fuses

Motor output up to kW	Nominal current at 400 V-50Hz max. A	fuse slow-blow A	Start up/ Nominal-current I _a / I _n	line cross-section (mm ²) for line length L (m)		
				L < 50	50 < L < 100	100 < L < 150
0,63	2,1	10	5-7 times	1,5	2,5	4
0,75/ 0,18	2,5/ 1,2					
1/ 0,25	2,6/ 1,4					
1,5/ 0,37	4,1/ 2,0					
1,8/ 0,44	4,4/ 2,1					
2,1/ 0,55	4,6/ 2,1	16				
3,2/ 0,8	6,4/ 2,7					
2,6/ 0,65	5,4/ 2,5					
4/ 1,1	10/ 6					
5,5/ 1,4	12,5/ 6,4					
6/ 1,5	13,8/ 7,0	32	4	6	10	
12/2,5	28/9,0	50	6	10	10	

9.3 Gear

NOTICE!

For transport, some gear types are fitted with a plug screw. Replace the plug screw by a ventilation screw (attached) before putting the unit into operation.

9.4 Load chain

- Before commissioning the load chain must be aligned and oiled.
- Move safety note and fixing wire away from the chain.

CAUTION!

Do not use grease for lubrication of load chain.

Without lubrication, manufacturer's warranty and/or liability will be void.

NOTICE!

Continuous, thorough lubrication will increase the life of the chain considerably.

10 Safety check

Before putting into service initially or when putting back into service, it must be checked whether:

- All fastening screws (if existent), socket pins, flap socket and safety devices are tightened and secured.
- The oil levels in the gear boxes are sufficient.
- All movements of the load comply with the symbols on the control switch.
- The chains are correctly placed, oiled and in good condition.

11 Functional test

11.1 Checks before the initial start-up

Lifting gear

- Load chains must not be twisted.
- Lubricate the load chain with gear oil or suitable chain lubricant before first loading.

Trolley drive

- The open-lying teeth of the trolley drive must be lubricated.

Hand gear for hand geared trolley

- Ensure correct fit of the hand chain, it must not be twisted and must hang freely.

11.2 Functional test

Lifting gear

Check lifting and lowering functions, initially without a load. The buttons of the control switch are marked with the symbols for lifting and lowering. The movement direction of the load (lifting or lowering) must correspond with the push buttons (lifting or lowering). This is the factory setting.

If the device lowers when the “lift” button is operated and lifts when the “lower” button is operated, the two phases of the net connection must be swapped.

The function of the end switch is to be checked initially by operating the end switch by hand. Then carefully move to the end position. If required, adjust end switch.

Then check the brake function under load. After releasing the buttons of the control switch, the load must be securely held.

Trolleys

Carefully move the trolley to the end positions and check the positions of the end stops.



NOTICE!

The limit switch function will only work if the movement direction of the load (lifting - lowering) corresponds to the push buttons of the control switch.

12 Maintenance

12.1 General

All monitoring, servicing and maintenance operations are to ensure correct functioning of the equipment; they must be effected with utmost care.

- Only “qualified persons” may do this work.
- Servicing and maintenance work must only be done when the hoist is not loaded.
- Records must be kept of all test results and measures taken.

12.2 Monitoring

The monitoring and servicing intervals stated are valid for operation under normal conditions and single-shift operation. In case of severe operating conditions (e.g. frequent operation with full load) or special environmental conditions (e.g., heat, dust, etc.), the intervals must be shortened correspondingly

12.3 Replacing the load chain



CAUTION!

If there is any visible damage and when the conditions for replacement are reached (i.e. one or several dimensions in the table have been reached, there is corrosion or elongation), the chain must be replaced.

When replacing the chain, also check the chain wheels.

Procedure:

- Only insert new chains in an unloaded state and as the chains that are currently in the device – i.e. not twisted.
- Remove chain from its fastening at the end and attach a chain link which is open at the side.
- A chain link which is open at the side, can easily be produced by grinding out a small piece. The opening must have the same thickness as the chain link.
- Hang a new original chain (same size and oiled) in the side opened chain link and insert it.
- Make sure the chain is not installed twisted.
- Make sure the chain links are aligned in one direction.
- Assemble the chain to the end fastening.



Illustration 15

Running of the chain into the chain container:

- Always run chains into the chain container by using the motor.

 **CAUTION!**
 Fill in the chain always motor driven.
 Never run the chain in by hand, as there is a risk of knotting which can cause malfunctions and damage to the device.

for hoists Type 4-8 with spur gear

 **NOTICE!**

The weld seam of the chain must lie to the inner side and be in contact with the sprocket wheels.

for hoists Type AK 9-10 with planetary gear

 **NOTICE!**

The weld seam of the chain must lie to the outer side and must not be in contact with the sprocket wheels.

Only for AK+AP 4-8

Chain end fastening 2 chain falls
 Type with threaded bolt (1)

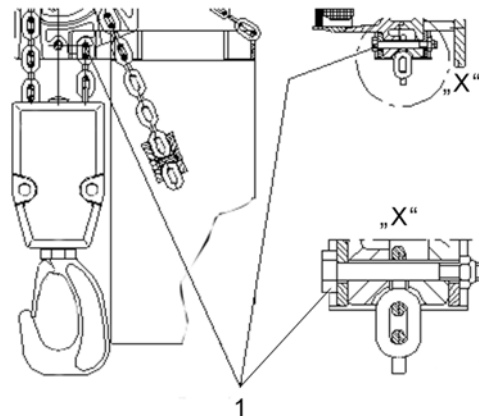

Illustration 16

chain threaded bolt AK+AP 4-8

	AK+AP4	AK+AP6	AK+AP7	AK+AP8
dn mm	6	8	10	12
dv mm	5,4	7,2	9	11

Exchange the bolt if the wear limit "dv" is reached.

Max. permitted wear < 10%.



Illustration 17

12.4 Brake motor AK 4-8

Brake: 180 V DC

Chain hoist Type	Nominal brake moment (Nm)	Nominal air gap (mm)	air gap max. (mm)	Rotor strength min. (mm)
AK 4	10	0,2	0,8	5,5
AK 6	20	0,3	0,8	7,5
AK 7	28	0,3	0,9	9,5
AK 8	28	0,3	0,9	9,5

12.5 Brake motor AK 9-10

Brake: 180 V DC

Chain hoist Type	Nominal brake moment (Nm)	Nominal air gap SLu (mm)	air gap max. (mm)	Rotor strength min. (mm)
AK 9-10	32	0,3	0,7	8,0

12.5.1 Assembling the brake

- 1 Insert the retaining ring (1) into the shaft slot.
- 2 Insert the feather key (2) into the motor shaft.
- 3 Fix hub (3) with retaining ring (1).
- 4 Assemble the friction plate (4) if existent.
- 5 Push the rotor (5) onto the hub (3).
- 6 Lock the magnet body with the 3 fastening screws (6).
- 7 Set air gap "a" (refer to "adjusting the air gap")
- 8 Assemble the dust-protection ring (7) if existent.
- 9 Electric connection

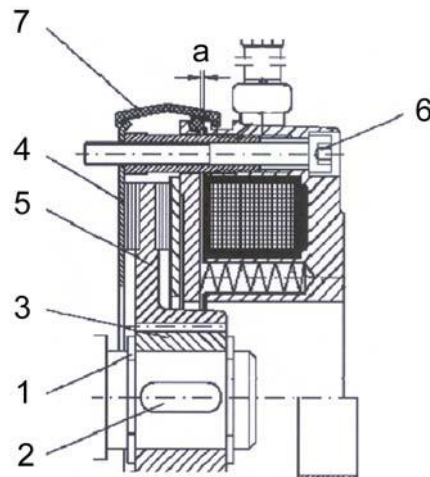

Illustration 18

12.5.2 Disassembly of the brake

Disassembly is performed in reverse order to the assembly.

12.5.3 Adjusting the air gap

View "X" on the brake.

- 1 Loosen the locking screws (6) by half a turn.
- 2 Turn the cap screws (8) into the magnetic body (9) anti-clockwise.
- 3 By turning the locking screws (6) clockwise, move the magnetic body (9) towards the anchor plate (10) using a feeler gauge until nominal air gap "a" is reached (see table).
- 4 Unscrew the cap screws (8) from the magnetic body clockwise.
- 5 Tighten the locking screws (6).
- 6 Check the air gap again and re-adjust if necessary.

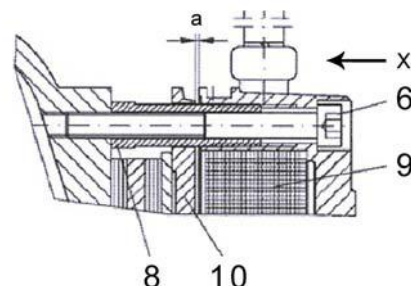

Illustration 19

12.6 Overload protection

If the hoist does not lift the permitted load, the overload protection must be adjusted. Adjustment may only be done by a service company, authorised by the manufacturer!

**DANGER!**

The factory setting of the overload protection is secured by a seal. Any guarantee becomes invalid if this setting is changed. Should maintenance be necessary, please contact a service company that is authorised by the manufacturer.

Depending on the type of hoist, the following variants are possible:

12.6.1 Slipping clutch

Illustration 20

12.6.2 Mechanical spring assembly

In case of overload the load must be lowered until it reaches the ground so that the spring assembly can release. Only thereafter it is possible to repeat the lifting motion.

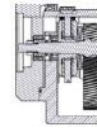
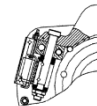

Illustration 21



Illustration 22

12.6.3 Electronic hoisting power limiter

Power consumption of the hoist motor is measured during lifting movement of a load by an adjustable power measuring device (overload guard). The setting is made via a separate relay for main and creep lifting speed. Power consumption of the motor is load-dependent and increases with the load. If the set value is exceeded, the relay responds immediately and switches the motor off via switching elements. After the overload protection has been activated the LOWER button must be pressed first so that the LIFT function can be activated again. Before lifting again the load must be reduced to the nominal load!



Illustration 23

13 Inspection**13.1 General Overhaul for motor-driven units**

The validated, national accident prevention regulations must be observed and the measures to reach "safe working periods (S.W.P.)" according to FEM 9.755.

After the "theoretical working time D" has been elapsed, the owner/user must take motor driven devices out of operation and effect a General Overhaul.

Further use of the equipment is only allowed after a licensed qualified person has proofed

- that further use is possible without doubt

and

- the conditions for further use have been determined

These conditions have to be written down in the test book.

The owner/user is responsible to make sure that these conditions are observed.

13.2 Periodic checks

Independently from the regulations of the individual countries, lifting devices must be checked at least yearly by a qualified person or licensed qualified person regarding its functional safety.

13.2.1 Components to be checked

The following must be checked:

- Dimensions of load chain, load hooks, pawls, bolts, ratchet wheels, brake linings.
The dimensions must be compared to the dimensions in the tables.
- A visual inspection for deformations, cracks and corrosion must be carried out.

13.2.2 Inspection intervals

	at commissioning	daily checks	1st maintenance after 3 months	Inspection and maintenance every 3 months	Inspection and maintenance every 12 months	Inspection and maintenance every 36/60 months
Inspection of the equipment by a qualified person (periodic inspection)					X	
screw connections	X				X	
brake function - brake discs	X	X				
overload protection as slipping clutch (if relevant)	X				X	
overload protection by current cut-off (electric hoist) (if relevant)	X				X	
overload protection by air relieve valve (pneumatic hoist) (if relevant)	X				X	
load chain, clean and oil	X	X*)	X	X		
load chain, elongation and wear				X		
load hook, cracks and deformation					X	
Bearings of chain pulleys, check and lubricate					X	
Hoist gear, oil change						X*)
Trolley wheels, wear					X	
Trolley wheels, lubricate toothed wheels	X*)		X*)	X*)		

*) see chapter "maintenance"

13.3 Checking the load chain

acc. DIN 685-part 5

L11 = pitch increase over 11 chain links

L1 = pitch increase over 1 chain link

dm = detected link thickness

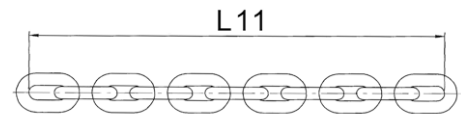

Illustration 24

Chain dimensions

Dimensions mm	Chain size					
	5x15	7x21	9x27	11,3x31	16x45	23,5x66
L11	171,4	238,8	300,8	348,1	505,6	743,0
L1	16,0	22,4	28,1	32,7	47,4	69,5
dm	4,6	6,5	8,2	10,2	14,4	21,2

WARNING!

When the dimensions listed in the table are reached due to wear or deformation, the chain must be replaced!

13.4 Checking the load hook

load hook and suspension AK 4 - AK 8

a1/a2 = biggest hook mouth width

h1 = eye dimension

t1/t2 = thickness of hook base

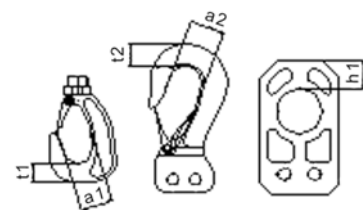

Illustration 25

load hook AK 9 + AK10

X = biggest hook mouth width

Y = measurement from hook no. 6 up

H = thickness of hook base

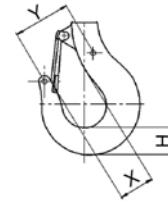

Illustration 26

Dimensions for load and suspension hook and eye for AK+AP 4-8

Dimension mm	AK+AP4		AK+AP6		AK+AP7		AK+AP8	
	Susp. a load		Susp. a load		Susp. a load		Suspension	
	1-str.	2-str.	1-str.	2-str.	1-str.	2-str.	1-str.	2-str.
a1 max.	37,5	43,5	43,5	60,0	60,0	69,5	--	--
a2 max.	39,0	39,0	57,0	57,0	57,0	66,0	60	60
h1 min.	18,0	18,0	31,0	31,0	31,0	40,0	40,5	40,5
t1 min.	17,1	20,9	20,9	27,6	27,6	40,0	--	--
t2 min.	21,9	21,9	33,4	33,4	33,4	63	77	77
							Load hook	
Hook No.	--	--	--	--	--	--	1	1,6
X	--	--	--	--	--	--	40	45
H	--	--	--	--	--	--	40	48

Please fill in the measured values before commissioning:

Capacity	t
a1	mm
a2	mm
h1	mm
t1	mm
t2	mm
X	mm
H	mm

Dimensions for load and suspension hook and eye for AK+AP 9-10

Dimension mm	Capacity in t / falls									
	5/1	6,3/1	10/2 10/1	12/2 12/1	15/3	20/4 20/2	25/5	25/2	30/6	40/8
Hook no.	1,6	1,6	4	4	6	6	8	6	10	12
X	45	45	56	56	--	--	--	--	--	--
Y	--	--	--	--	130	130	145	130	160	180
H	48	48	67	67	85	85	95	85	106	118

Please fill in the measured values before commissioning:

Capacity	t
X or Y	mm
H	mm

CAUTION!

When the dimension of hook opening width is deformed more than 10% or when the dimension of the hook bottom thickness is fallen short of by 5% due to wear, the hook must be replaced.

13.5 Inspection – Gear – Oil level

Check oil level all 3 month.

	Locking screw(C)	Tool
AK 4 – AK 6	M10	SW8
AK 7 – AK 8	M12	SW10

Solve the locking screw (C) a bit. (do not remove)
If oil drips out = level OK.
Tighten the screw.

If no oil drips out, carry out maintenance and oil change.
(see chapter maintenance)

AK 9 - 10	Oil gauge glass (C)

Oil gauge glass half full = level OK
No oil observable = carry out maintenance and oil change.
(see chapter maintenance)

AK 4-8

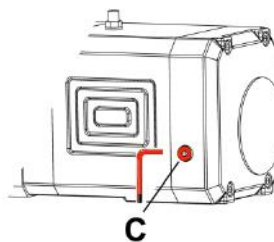

AK9-10

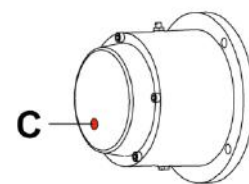

14 Service



14.1 Load chain

Wear at the links is mainly due to insufficient maintenance of the chain.

To ensure optimal lubrication of the links, the chain must be lubricated at regular intervals, depending on usage.

- Lubricate the chain with a lubricant that creeps, e.g. automotive gear oil.



- Always lubricate the chain when it is not under load so that the oil can wet the links affected by wear. It is not sufficient to lubricate the chain from the outside, as this will not ensure the formation of a lubricating film within the links. The adjacent link points must always be lubricated to prevent excessive wear.
- If the same lifting operations are carried out constantly, the switching area from a lifting to a lowering movement must be given special attention.
- Thoroughly effected lubrication of the chain will prolong the life of the chain by approx. 20 times, compared to dry run with unlubricated chain.
- Wash dirty chain with petroleum or a similar cleaner, under no circumstances heat the chain.
- If there are environmental influences that foster wear, such as sand, a dry lubricant should be used, e.g. graphite powder.
- When lubricating the chain's condition of wear should be checked.

Use		Recommendation		Interval
Load chain		Gear oil for example: FUCHS RENOLIN PG 220 or special chain lubricant Use NO grease!	0,2 l	3 month

⚠ CAUTION!

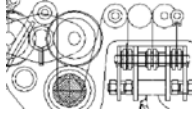

Do not use grease for lubrication of load chain.
Without lubrication, manufacturer's warranty and/or liability will be void.

14.2 Pulleys

Use		Recommendation		Interval
Pulleys		FUCHS RENOLIT FEP2	Acc. to demand	12 month

14.3 Load hook

- Check bearings and pulleys yearly
- Clean and lubricate the bearings of hooks and pulleys with grease
- Slight bearings are maintenance free
- When bearings resp. slight bearings are worn of, change the complete pulley

Use		Recommendation		Interval
Load hook bearing		FUCHS RENOLIT FEP2	Acc. to demand	12 month

14.4 Hoist gear

- Low maintenance.
- Regular lubricant checks required
- Exchange synthetic lubricants after 3 years
- Shorter maintenance intervals for particularly difficult operating conditions, e.g. increased dust and pollution loads or constant operation of the hoist with the highest load
- Lubricant: synthetic, viscosity VG 220

AK4 – AK8

AK9+AK10

A = Oil fill in or air discharge screw
 B = Oil drain plug
 C = Oil level glass

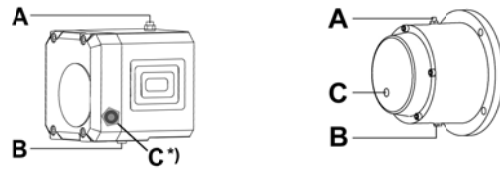

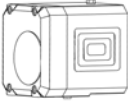
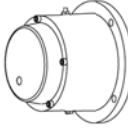





Illustration 27

Use		Recommendation		Interval
Spur gear		FUCHS RENOLIN PG 220	AK/AP4 – 0,80 l AK/AP6 – 1,00 l AK/AP7 – 1,90 l AK/AP8 – 1,90 l	Lubricant change 3 years
Planetary gear		FUCHS RENOLIN PG 220	AK/AP9 = 0,4 l AK/AP10 = 3 l	Lubricant change 3 years
Spur gear *) Planetary gear			Maximum fill level = gauge full filled Minimum fill level = gauge half filled	

*) only by explosion proof electrical equipment

14.5 Trolley

- Trolleys are lifetime lubricated, Refill lubricant is normally not necessary.
- Lubricate gear rim and pinion drive each ¼ year or if required more often, with grease.

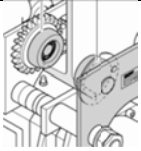
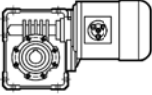
Use		Recommendation		Interval
Pulleys Gear rim Drive pinion		FUCHS RENOLIT FEP2	0,1 kg	3 month
Travelling gear If available		SHELL Tivela S320	---	Life time lubrication

14.6 Electric motor

For the motor it is sufficient to keep the cooling airways clean and monitor the roller bearing and its lubrication status.

A high temperature fat must be used if the roller bearing is replaced.

 **CAUTION!**
 Brake linings and surfaces must always be clean and fat-free. Even very small amounts of dirt can reduce the braking moment considerably.

14.7 Lubricant selection

FUCHS	SHELL	ESSO	ARAL	MOBIL	TOTAL	CASTROL	KLÜBER
Renolin PG 220	Tivela S 20	Glycolube 220	Degol GS 220	Glygoyle 30	CARTER SY 220	--	Klübersynt GH 6-220
Renolin PG 320	Tivela S 320	Glygolube 320	Degol GS 320	Glygoyle 320	--	--	Klübersynt GH 6-320
Renolin PG 460	Tivela S 460	Glygolube 460	Degol GS 460	Glygoyle 460	--	Alphasyn PG 460	Klübersynt GH 6-460
Renolit FEP2	Alvania EP2	Unirex EP2	--	Mobilux EP2	MULTIS EP2	--	--
Renolin B10 VG32	Tellus Oil 32	--	--	--	--	--	--
Stabylan 5006	--	--	--	--	--	Optimol Viscoleb 1500	Klüberoil 4UH 1-1500

14.8 Lubricant for food industry – selection (as option*)

	FUCHS	SHELL	MOBIL	CASTROL	KLÜBER
Gear	Geralyn SF 220	Cassida Fluid GL 220	Glygoyle 220	Optimol GT 220	Klübersynt UH1-220
Driving gear	Geralyn SF 320	Cassida Fluid GL 220	Glygoyle 320	Optimol GT 320	Klübersynt UH1-320
Load chain	--	--	Lubricant FM 100	Optimol Viscoleb 1500	--
Load hook Pulley Spur gear Pinion	--	FM Grease HD 2	Mobilegrease FM 222	--	--

* must be mentioned by order

15 Trouble

Please pay attention to the following in case of problems:

- Troubles with the equipment must only be repaired by qualified personnel.
- Secure the unit against unintended operation start.
- Put up a warning note indicating that the unit is not to be used.
- Secure the working area of moving parts of the unit.
- Please read the chapter "Safety instructions".

Notes on the repair of faults are found in the following table.

For the repair of failures please contact our service department.



CAUTION!

Trouble caused by wear or damage to parts such as wire ropes, chains, chain wheels, axes, bearings, brake parts, etc., must be remedied by replacing the parts with original spare parts.

16 Remedy

Problem*	Unit	Cause	Remedy
Unit cannot be switched on	Electric Hoists	No main power	Check connection to mains supply
		Phase sequence not correct (with low voltage control)	exchange 2 phases <i>(see warning note at the plug)</i>
Hoist motor does not run	Electric Hoists	Fuse burnt out	Replace the fuse
		Defective switching unit in the control button switch	Replace the switching unit
		Interruption in the control cable	Check control cable and replace if necessary.
		Defect of capacitor (only for alternating current 1).	Replace the capacitor
	Pneumatic hoists and winches	Defective coil - mechanic or electric overload	Motor must be repaired by a specialist If the unit is suitable for explosive atmosphere, the motor must be returned to the manufacturer for repair!
		Operation pressure/ quantity of air is too low	Check connection to mains supply
Hoist motor runs – load is not lifted	For motor driven chain hoists, and winches	After prolonged standstill	See maintenance - pneumatic motor
		Overload protection is activated - (with overload)	Reduce the load to nominal load
		Overload protection is activated - (with =< nominal load)	Check settings and reset if necessary
Hoist motor is running – chain does not lower	For motor driven chain hoists.	No or incorrect power transmission	Let the unit be repaired by an expert For EX-hoists, please clarify with the manufacturer what to do!
		Blockage due to chain link pointing sideways in the feed from the chain container*	Check the chain - lubricate if necessary and/or select a larger chain container so that the chain can be properly arranged before the inlet
Motor hums and uses excessive current	Electric hoists and winches	Defective coil	Motor must be repaired by a specialist If the unit is suitable for explosive atmosphere, the motor must be returned to the manufacturer for repair!
		Rotor is rubbing	Motor must be repaired by a specialist If the unit is suitable for explosive atmosphere, the motor must be returned to the manufacturer for repair!
		Brake does not release	See problem "Brake does not release"
		Defect of capacitor (only for alternating current 1).	Replace the capacitor
		Defect of starter relay (only for alternating current 1).	Replace the starter relay
		Phase failure (only direct control)	Find the cause and repair
Motor does not brake or has excessive afterrunning.	Electric hoists and winches	Switching error after intervention in the electric circuit	Check the electric connection of the brake acc. to the wiring diagram
	For motor driven units.	Brake linings are worn or dirty.	Brake lining carrier must be changed completely If the unit is suitable for explosive atmosphere, the brake must be returned to the manufacturer for repair!
		Air gap is too large	Re-adjust the air gap If the unit is suitable for explosive atmosphere, the brake must be returned to the manufacturer for repair!
Brake does not release	Electric hoists and winches	Brake rectifier defective	Replace the brake rectifier If the unit is suitable for explosive atmosphere, the brake must be returned to the manufacturer for repair!
		Brake current relay defective	Replace the brake current relay
		Brake coil is defective	Replace the brake coil If the unit is suitable for explosive atmosphere, the brake must be returned to the manufacturer for repair!
		Permissible air gap is exceeded due to worn out brake lining	Re-adjust the air gap and exchange the brake lining if necessary If the unit is suitable for explosive atmosphere, the brake must be returned to the manufacturer for repair!
	Pneumatic hoists and winches	Power drop in the mains power line > 10%	Provide correct power supply voltage
		Operation pressure/ quantity of air is too low	Check connection to mains supply
Fuses burnt out or motor contactor is triggered	Electric hoists and winches	Short circuit in component	Eliminate the short circuit
		Motor has a short circuit in the body or windings	Correct the problem by a specialist For EX-hoists, please clarify with the manufacturer what to do!
		Motor is switched incorrectly	Correct the switching
		Wrong type of fuse	Replace the fuse with correct one <i>(see table "fuses")</i>

*) as far as applicable

17 Decommissioning



WARNING!

It is essential that the following points are observed in order to prevent damage to the equipment or critical injury when the device is being decommissioned:

It is mandatory that all steps for decommissioning the machine are carried out in the indicated sequence:

- First secure the working area for decommissioning, leaving plenty of space.
- Read the chapter "Safety instructions".
- Disassembly is carried out in reverse order to the assembly.
- Please make sure that all operating material is disposed of in accordance with environmental regulations.

17.1 Temporary decommissioning

- Measures are as above.
- Also read the chapter "Transport and storage".

17.2 Final decommissioning/disposal

- Measures are as above.
- After disassembly, ensure that the disposal of the equipment and any materials it contains is carried out in accordance with environmental regulations.

18 Additional documents

18.1 Electric wiring diagrams

Electric wiring diagrams are attached to the consignment or included in the terminal box.
Except for units supplied without control.

18.2 Radio control (as option)

Should the unit be fitted with radio control, a manual for radio control is attached to the consignment.