



GB

Installation,- Operating and Maintenance Instructions

HADEF Single Girder Manual Underslung Crane

Type EDEE

also available as adapter crane

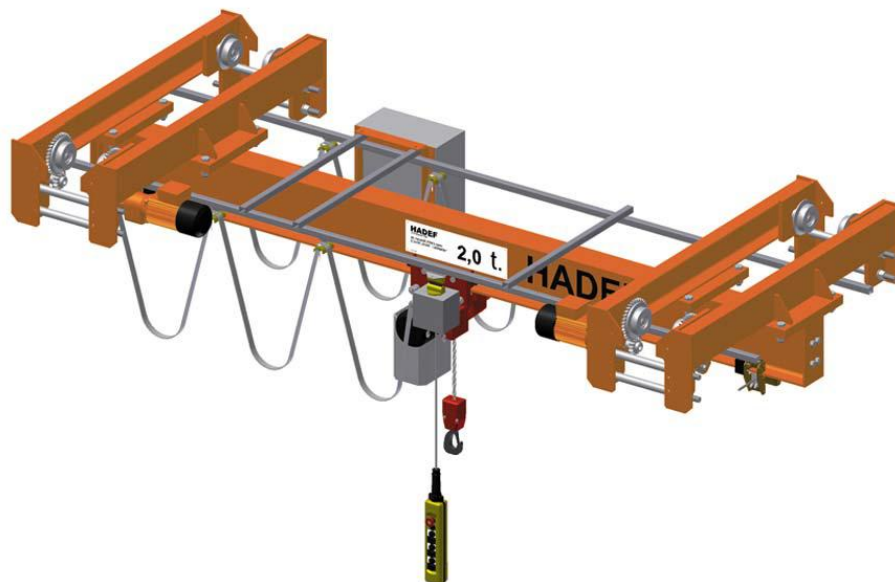

HADEF

Internet Download: www.doc.hadef.de/bedee_gb.pdf

 **NOTE!**

The installation or mounting instructions for incomplete machines you'll find in chapter "Installation"

© by Heinrich de Fries GmbH

Heinrich de Fries GmbH, Gauss Str. 20, D-40235 Düsseldorf



Heinrich de Fries GmbH wird im Weiteren als HADEF bezeichnet.

Originalbetriebsanleitung in deutscher Sprache.

Eine Kopie kann bei HADEF schriftlich angefordert werden.

Änderungen vorbehalten.



Heinrich De Fries GmbH will be named HADEF in the following text.

Translation of the original operating and maintenance instructions

A copy is available from HADEF on request.

Subject to changes.

Table of Contents

1	Information	4
1.1	Indications to determine the used part of the theoretical usage life.....	4
2	Safety	5
2.1	Warning notice and symbols.....	5
2.2	Duty of care of the owner.....	5
2.3	Requirements for the operating personnel	6
2.4	Appropriate use	6
2.5	Basic safety measures	7
2.1	Safety Instructions	7
3	Transport and Storage	8
3.1	Transport.....	8
3.2	Safety device for transport	8
3.3	Storage	8
4	Description	9
4.1	Areas of application	9
4.2	Design.....	9
4.3	Functions.....	10
4.4	Important Components	10
5	Technical data.....	11
6	Installation.....	12
6.1	Assembly - for complete cranes	12
6.2	Assembly – partially assembled cranes.....	13
6.3	Assembly – Adapter Cranes.....	13
6.4	Table of screws.....	14
6.5	Tools	14

7	Operation	15
8	Operation	16
9	Commissioning	17
9.1	General	17
9.2	Electrical connection	17
9.3	Gear	18
10	Safety check	19
11	Functional test	20
11.1	Checks before initial start-up	20
11.2	Functional test.....	20
12	Maintenance	21
12.1	General	21
12.2	Monitoring	21
12.3	Brake motor	21
13	Inspection	23
13.1	General Overhaul for motor-driven units	23
13.2	Periodic checks	23
13.3	Inspection intervals.....	23
14	Service	24
14.1	Trolley.....	24
14.2	Lubricant selection	24
15	Trouble	25
16	Remedy	26
17	Decommissioning	27
17.1	Temporary decommissioning	27
17.2	Final decommissioning/disposal.....	27
18	Additional documents	28
18.1	Electric wiring diagram	28
18.2	Frequency converter	28
18.3	Radio control	28
18.4	Operating instruction for cranes.....	28

1 Information

HADEF products meet European Union requirements, in particular the EU Machine Directive (2006/42/EG).

The entire company works acc. to a certified quality assurance system as per ISO 9001.

The production of components at HADEF is subject to strict, intermediate checks.

After assembly, each HADEF product is subject to a final test with overload.

For the operation of hoists, the accident prevention regulations BGV D8, BGV D6 and BGR 500 apply in Germany, amongst others.

The stated performance of the devices and meeting any warranty claims require adherence to all instructions in this manual.

Before delivery, all HADEF products are packed properly. Check the goods after receipt for any damage caused during transport. Report any damage immediately to the forwarding agent.

This manual allows a safe and efficiently use of equipment. Images of this manual are for a principle understanding and can be different from the real design.

NOTE!

We refer to the prescribed equipment tests before initial start-up, before putting back into operation and the regular periodic inspections.

In other countries any additional national regulations must be observed.

1.1 Indications to determine the used part of the theoretical usage life.

For motor driven units.

The equipment (rope hoists, chain hoists, winches as well as crane hoisting units) are classified in drive groups (duty classification) according to their intended mode of operation, running times and load collectives and dimensioned according to the requirements derived from these. (I.e. DIN 15020, ISO 4301/1, FEM 1.001, FEM 9.511). They are thus only designed for a limited period of use with regard to the overall dimensioning and certification.

After the total period of use as elapsed, measures must be taken where parts are checked and exchanged as per indication by the manufacturer. After that a new maximum usage period is determined. See also the accident prevention regulations BGV D 8, winches, lifting and pulling devices.

NOTE!



Commitment

A general overhaul may only be performed by HADEF or by a specialized company, authorized by HADEF.

2 Safety

2.1 Warning notice and symbols

Warnings and notice are shown as follows in these instructions:

 DANGER!	This means that there is a high risk that leads, if it is not avoided, to death or severe injury.
 WARNING!	This means that there is a risk that could lead, if it is not avoided, to death or severe injury.
 CAUTION!	This means that there is little risk that could lead, if it is not avoided, to slight injury or damage to the device or its surrounding.



NOTICE!

Gives advice for use and other useful information.



Danger from electricity.



Danger from explosive area.

2.2 Duty of care of the owner

The unit was designed and built following a risk analysis and careful selection of the harmonized standards that are to be complied with, as well as other technical specifications. It therefore represents state-of-the-art technology and provides the highest degree of safety.

Our delivery includes the hoist supplied beginning at its suspension and ending at the load hook and if supplied with control, the control line/hose that leads to the hoist. Further operating material, tools, load attaching devices as well as main energy supply lines must be assembled according to the valid rules and regulations. For explosion-proof equipment, all these parts must be approved for use in area prone to explosion, or they must be suitable for use in area prone to explosion. The owner is responsible for this.

However, in everyday operation this degree of safety can only be achieved if all measures required are taken. It falls within the duty of care of the owner/user of the devices to plan these measures and to check that they are being complied with.

Complete the operating and installation instructions by any instructions (regarding supervision or notifications) that are important for the special kind of use of the equipment, i.e. regarding organization of work, work flow and human resources.

In particular, the owner/user must ensure that:

- The unit is only used appropriately.
- The device is only operated in a fault-free, fully functional condition, and the safety components, in particular, are checked regularly to ensure that it is functioning properly.
- The required personal protective equipment for the operators, service and repair personnel is available and is used.
- The operating instructions are always available at the location where the equipment is used and that they are legible and complete.
- The unit is only operated, serviced and repaired by qualified and authorized personnel.
- This personnel is regularly trained in all applicable matters regarding safety at work and environmental protection, and that they are familiar with the operating manual and, in particular, the safety instructions it contains.
- Any safety and warning signs on the devices are not removed and remain legible.
- Devices for use in area prone to explosion must (from customer's side) be earthed with a shunting resistor of $< 10^6 \Omega$ against earth.

 WARNING!
It is not allowed to make constructive changes of the equipment!

2.3 Requirements for the operating personnel

The units may only be operated by qualified persons that are appropriately trained and that are familiar with it. They must have their employer's authorisation for operation of the units.

Before starting work, the operating personnel must have read the operating and installation instructions, especially the chapter "Safety Instructions".

This is especially important for operating personnel that rarely uses the equipment, i.e. for installation or maintenance work.



DANGER!

In order to avoid severe injury, please pay attention to the following when using the equipment:

- Use protective clothes/equipment.
- Do not wear long hair hanging down open.
- Do not wear rings or other jewellery.
- Do not wear cloths that are too big/wide.

2.4 Appropriate use

Appropriate use of the crane is horizontal movement of loads in direction of the beam and crane runway. The cranes can be used with suitable lifting gears.

Please observe the separate operating manual for the hoist.

The permitted safe working load of the devices must not be exceeded! An exception can be made during the load test, carried out by a licensed expert in accordance with the accident prevention regulations UVV BGV D6 before initial operation.

- The permitted environmental temperature during equipment operation is -20°C to $+40^{\circ}\text{C}$.
- The standard equipment is made for indoor use. For outdoor use we recommend a weather protection paint and protection covers to protect the hoists. For electric equipment, the electric control lines and electric devices must also be protected. Higher protection classes are also recommended for outdoor use.
- Defective devices and load suspension devices must not be used until they have been repaired! Only original HADEF spare parts must be used. Non-compliance will result in any warranty claims on HADEF becoming void.
- Liability and warranty will become void if unauthorized modifications of the units are made by the user!



NOTE!

If the units are not used appropriately, it is not possible to ensure safe operation.

The owner and operator have sole liability for all personal injury and damage to property arising from inappropriate use.



DANGER!

It is not allowed:



- pulling loose of stuck loads, dragging of loads and inclined pulling is not allowed.
- in explosive atmosphere, except the unit is especially modified for it and marked by an indication label
- to transport people
- persons must not stand under a suspended load

2.5 Basic safety measures

- Only use the hoists appropriately.
- Never load the devices beyond their permitted working load limit.
- Please observe the accident prevention regulations (UVV).
- Should the equipment be used outside of Germany, please pay attention to the national regulations that apply.
- Grounds and supporting structures used in conjunction with this equipment must provide an adequate stability. In case of doubt, please consult a structural engineer.
- If the equipment has not been used for a period of time, carry out visual checks of all main components and replace any damaged parts with new, original spare parts.
- Please pay attention to the regulations for load carrying devices UVV BGR 500 for both positive and non-positive methods of attaching loads.
- Do not use defective equipment.
- Any damage and faults must be reported to a responsible supervisor immediately.
- If the unit is put into motion, any persons in the immediate vicinity must be informed by calling to them!
- Load-attaching devices must be in perfect shape.
- The load must not bump against the crane construction.

2.1 Safety Instructions

Please pay attention to the following additional safety instructions to prevent injury:

	 DANGER!
It is not permitted to use the unit in an area at risk from explosion!	

- Please pay attention to the operating and maintenance instructions.
- Please pay attention to the operating and maintenance instructions of the hoists.
- Please pay attention to the warnings mentioned on the device.
- Please consider oscillations of the load and the stopping distance.
- Please adhere the safe distances.
- Please insure good sight during operation.
- In case of trouble stop operation immediately and eliminate the defect.

3 Transport and Storage



CAUTION!

Transport may only be done by qualified personnel. No liability for any damage resulting from improper transport or improper storage.

3.1 Transport

HADEF devices are checked and if so adequately packed before delivery.

- Do not throw or drop the equipment.
- Use adequate means of transport.

Transport and means of transport must be suitable for the local conditions.

3.2 Safety device for transport



NOTE!

Should a safety device for transport exist, please remove it before commissioning.

3.3 Storage

- Store the equipment at a clean and dry place.
- Protect the equipment against dirt, humidity and damage by an appropriate cover.
- Protect hooks, wire ropes, chains and brakes against corrosion.

4 Description



4.1 Areas of application

The devices must be as far as possible installed in a covered room.

If they are used in the open, protect the units against the effects of weather such as rain, hail, snow, direct sunshine, dust, etc. - we recommend to use a cover in parking position. If the device is set up in a continuously humid environment with strong temperature fluctuations, the correct functioning of the motor and the brake are endangered by the forming of condensation.

Ambient temperature: - 20°C up to + 40°C. Humidity: 100 % or less but not under water

During longer periods of standstill, corrosion may reduce the function of the brake.

	 DANGER!
It is not permitted to use the unit in an area at risk from explosion!	

4.2 Design

HADEF Single girder manual underslung cranes can be used with any type of HADEF hoists combined with trolley.

According to DIN 15018

Electric and pneumatic cranes according to H2/B3

Manual cranes according to H1/B2

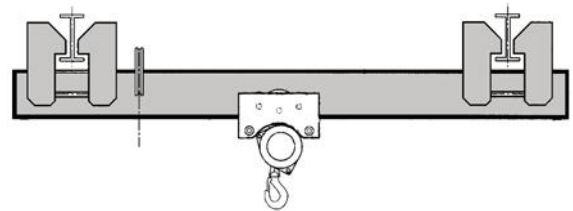

Illustration 1

As standard, the cranes are supplied with welded end carriages, version „C”.

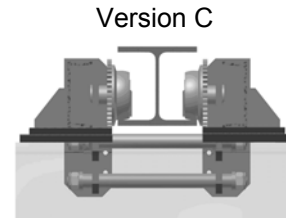

Illustration 2

Optionally the screwable version „A” can be taken to assemble the end carriages should this be more advantageous.

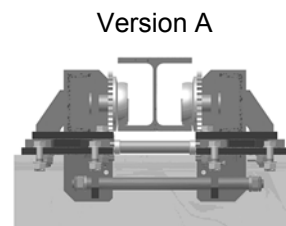

Illustration 3

4.2.1 Adapter Cranes

Adapter cranes are supplied without main beam.

The main beam can be bought nearby the site and assembled there which reduces costs for transport.

The end carriages are available in two versions - with screw fittings or weldable.

4.3 Functions

Movement direction

- 1 electrical trolley drive
- 2 electrical crane drive
- 3 electrical lifting and lowering

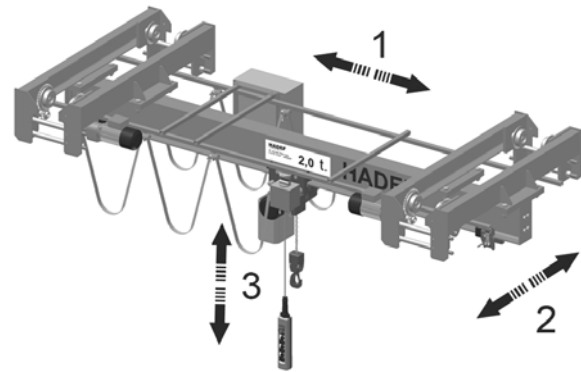

Illustration 4

4.4 Important Components

4.4.1 Main beam

Profile main beam

4.4.2 End carriage

Structural tubing shape including running wheels and travel drive

Standard as welded version „C“

As option available screw fittings, version „A“

4.4.3 Wheels

Machined steel wheels with ball bearing and wheel flange

4.4.4 Drive

3-phase current motor

4.4.5 Electrical control

Contact control or radio control by frequency converter for step less driving speed

4.4.6 Lifting unit and power supply

See separate instruction

5 Technical data

Capacity	Span up to	Wheel base	Max. wheel load with hoist Type 66/04AKE	Max. wheel load with hoist Type 29/06EE	Max. wheel load with hoist Type 62/05E	Wheel Ø	Stepless trolley drive from...to	Motor power 2x	Weight * approx.
kg	mm	mm	kg	kg	kg	mm	m/min	kW	kg
1000	7000	1200	764	778	753	120	0,5 - 20	0,37	834
	9000	1200	825	839	814	120		0,37	1073
	12000	1600	1003	1017	992	150		0,37	1781
	15000	2000	1285	1299	1274	200		0,37	2903
2000	7000	1200	1307	1337	1282	120		0,37	907
	9000	1200	1402	1432	1377	120		0,37	1273
	12000	1600	1606	1636	1581	150		0,37	2080
	13000	2000	1746	1776	1721	200		0,37	2634
	15000	2000	1902	1932	1877	200		0,37	3256
3200	7000	1600	1966	2000	-	150		0,37	1062
	9000	1600	2097	2131	-	150		0,37	1566
	12000	1600	2278	2312	-	150		0,37	2268
	13000	2000	2442	2476	-	200		0,37	2918
	15000	2000	2591	2625	-	200		0,37	3505
5000	6000	1600	2875	2972	-	150		0,37	1090
	10000	2000	3171	3268	-	200		0,37	2193
	13000	2000	3413	3510	-	200		0,37	3135
	15000	2000	3618	3715	-	200		0,37	3943
6300	6000	2000	3712	3730	-	200		0,37	1560
	7000	2000	3758	3776	-	200		0,37	1701
	10000	2000	3954	3972	-	200	0,37	2411	
	12000	2000	4095	4113	-	200	0,37	2950	
	15000	2000	4351	4369	-	200	0,37	3843	
8000	15000	2000	5350	5658	-	250	0,37	4316	
10000	8000	2000	5836	6145	-	250	0,37	2378	
	10000	2000	5988	6297	-	250	0,37	2915	
	11000	2000	6144	6353	-	250	0,37	3118	
	12000	2000	6138	6447	-	250	0,37	3469	

*Weights without lifting unit and standard profile

3-phase current motor 400V/50Hz, IP55

Listed data are standards. Intermediate sizes possible.

Find order-related data on type plate of the crane and lifting unit.

6 Installation

Assembly depends on the local environment. The crane must be assembled stress-free. The runway must be perfect.

Operating regulations for cranes in accordance with §§ 29-43 of the accident prevention regulations "cranes" BGV D6.

There must be end stops (provided by the customer) on both ends of the crane runway.

They must be attached so that the rubber buffers or the trolley wheels drive against them in their end position.

Generally, additional lifting gear (e.g. fork lift, lifting platforms) will be required for the assembly. These must take the weight of the devices safely.

6.1 Assembly - for complete cranes

The crane is fully assembled and installed, including the hoist and power supply for the electric version.

Prepare crane for proper and safe transport with a truck-mounted crane, on the ground

Consider two different procedure for assembly for the different running wheel diameters

Find suitable running wheel diameters in the crane test book

For electric cranes the customer must effect electric wiring according to the rules and regulations

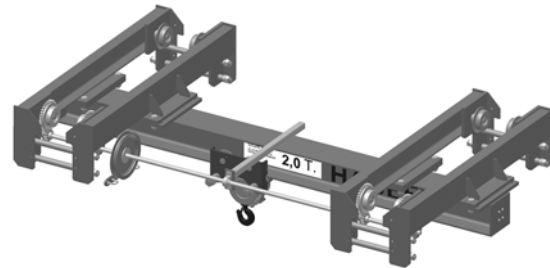

Illustration 5

Assembly up to wheel diameter 150 mm

- Lift up the crane by suitable lifting hoist
- Loose fixing screws of end carriage (2)
- Loose the screws of the connection bolts (10) only at one side
- Slotted holes (9) are provided for pulling the end carriage halves apart; push the running wheels (5) on the lower flanges of the crane travelling beam
- Push the end carriage halves together again
- Adjust the end carriage halves into the correct position (2) by pin through the provided bores
- Tighten the screws of end carriages

Assembly from wheel diameter 200 mm

- Remove the bolted endplates (6)
- Loose pin locks (8) and wheels (5) and remove wheel axles (7)
- Lift up the crane bridge up to the wheels (5) are in position over the lower flanges of crane rail beam
- Assemble the wheels (5); put through the wheel axles (7) and secure by pin locks (8) again

- Set up the crane bridge; the running wheels must be bear on the lower flanges of crane rail beam
- Slow test drive without load about the whole distance of crane rail way; check proper drive
- Pay attention of interfering edges and a correct drive without barriers; check proper position of crane end stops

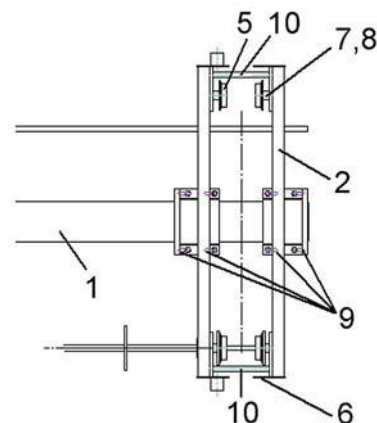

Illustration 6

6.2 Assembly – partially assembled cranes

The crane is, apart from the hoist, fully assembled and installed, incl. power supply for electric cranes.

- Install the hoist according to its operation instruction
- Assemble electric cranes according to the wiring diagram
- Proceed assembly as mentioned before the complete crane

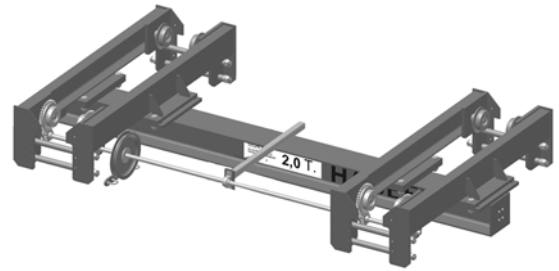

Illustration 7

6.3 Assembly – Adapter Cranes

Scope of supply:

- 1 set end carriages
- 1 set adapter plates with screw fittings including, optionally
- 1 set weldable adapter plates



Illustration 8

Connection A

- bore main beam acc. former plate
- Install end carriages at the main beam with attached fixing screws. Tightening torque acc. table.
- secure with safety nuts
- check all screw connections

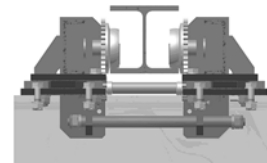

Illustration 9

Connection C

- weld-on the adapter plates onto the main beam
- weld the end carriages onto the main beam

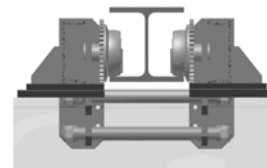

Illustration 10

NOTE!

Welding at crane components must be done only by a certified welder. (acc. DIN 18800)

6.4 Table of screws





Tighten the screws with tightening moment mentioned in the table

Thread	Tightening moment (Nm) in property class	
	8.8	10.9
M 6	10,4	15,3
M 8	25,3	37,2
M 10	51	75
M 12	87	128
M 14	139	205
M 16	214	314
M 18	280	390
M 20	431	615
M 22	530	750
M 24	742	1159
M 27	1000	1400
M 30	1350	1900
M 33	2000	2800

coefficient of friction 0,12 - 0,14 μ_{ges}

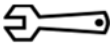
6.5 Tools

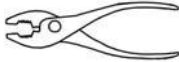
Special tools are not required.

Size	Tool	Use	
misc.		Adapter assembly	
			
			
misc.			

7 Operation

Only people that are familiar with the operation of the lifting devices and cranes may be entrusted with their operation. They must be authorized by the employer for the operation of the equipment. The employer must ensure that the operating instructions are available near the equipment and that they are accessible for the operating personnel.

The shown control switches are only for the optical information. They can be different acc. the delivery.

Pendant control – 6 push buttons

- 1 Emergency stop
- 2 Selection switch (as option)
- 3 Lifting (slow - fast)
- 4 Lowering (slow - fast)
- 5 Trolley travel right side (slow - fast)
- 6 Trolley travel left side (slow - fast)

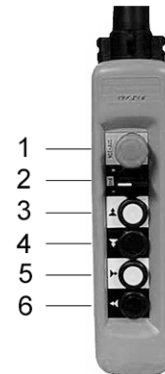

Illustration 11

Radio control

- 1 Lowering (slow - fast)
- 2 Lifting (slow - fast)
- 3 Trolley travel left side (slow - fast)
- 4 Trolley travel right side (slow - fast)
- 5 Crane travel south (slow - fast)
- 6 Crane travel north (slow - fast)
- 7 no function
- 8 no function
- 9 start
- 10 start
- 11 emergency stop



Illustration 12

Push button functions

- Relieved push button = stand still
- push button half pushed = slow speed
- push button pushed completely = fast speed

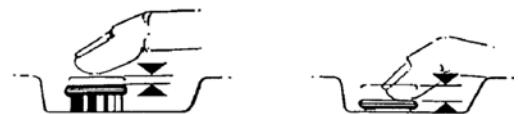

Illustration 13

Red Emergency-Stop button

- button pushed = stand still
- turn the button clockwise = free functions

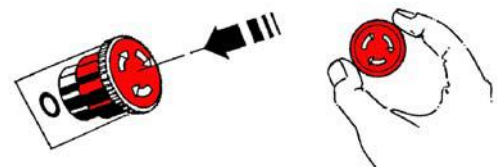

Illustration 14

8 Operation

The following, important points must be observed when operating the equipment:

- Read the safety instructions.
- Never load the devices beyond their working load limit.
- When changing the motor turning direction, allow the motor to come to a standstill first.
- The prescribed maintenance intervals must be adhered to.

- Observe the duty cycle, i.e. intermittent operation S4-40% ED (as per VDE 0530) means that in a period of 10 minutes the motor can operate – no matter the height of the load – for 4 minutes. It is therefore irrelevant whether the 4 minutes are continuous (i.e., in case of very high lifting heights) or are made in intervals.
- The lifting tackle or the load must be securely attached to the hook and be seated at the bottom of the hook. The safety catch must always be closed.



DANGER!

It is not allowed:

- pulling loose of stuck loads, dragging of loads and inclined pulling is not allowed.
- in explosive atmosphere, except the unit is especially modified for it and marked by an indication label
- to transport people
- persons must not stand under a suspended load

9 Commissioning

9.1 General

Should the unit be used in Germany, please observe the accident prevention regulations, in particular BGV D8, BGV D 6 and BGR 500 (VBG 9a).

For other countries: Inspections as above. Please observe the national rules and regulations and the instructions in this manual!

NOTE!

Hoists up to 1000 kg capacity and without motor-driven trolleys of hoisting unit must be tested by a “qualified person” before putting into operation for the first time.

Hoists of 1000 kg capacity and up or with more than one motor-driven hoist movement; i.e. lifting and trolley movement, must be tested by a “licensed quality person” before putting in operation.

An exception is “hoists ready for operation” acc. To BGV D6 II§25(4) with EU-declaration of conformity.

Definition “qualified person” (former expert)

A “qualified person” has learned, due to occupational training and experience and the job that the person has done, the skills needed to tests the material for one’s work.

Definition “licensed qualified person” (former approved expert)

A “licensed qualified person” has, due through special occupational training, knowledge about testing of the material for one’s work and knows the national accident prevention regulations and other prescriptions and technical regulations. This person must test the material for one’s work regularly with regard to design and kind of use. The license will be given to qualified person be the approved supervision authorities (ZÜS).

9.2 Electrical connection

9.2.1 Main connection

Technical data of motors see chapter “technical data” or take it from the type plates.

Wiring diagrams or fusing information of supply see next table.

- Choose the wire cross section acc. VDE 0100
- Install cable ends with cable skinner
- Put the connection cable strain-relieved into the connection plug
- Protect the supply line acc. VDE 100

9.2.2 Control connection

Control cable with connection plug as standards. Plug in for setting in operation.

Changes at connection cable are only allowed by an expert.

9.2.3 Cable connection - brake

The service reduced co-current spring pressured brakes are installed acc. wiring diagram at works

9.2.4 Wiring diagrams

Wiring diagrams for standard and special cranes are placed in the control box.

9.2.5 Cable cross section and fuse protection

Provide cable cross section and fuse protection acc. VDE 100.

For totally demand add all motor demand data. See crane test book.

9.3 Gear

Should the gear not be closed, the level of lubricant must be checked before putting the device into operation.

**NOTICE!**

For transport, some gear types are fitted with a plug screw. Replace the plug screw by a ventilation screw (attached) before putting the unit into operation.

10 Safety check

Before putting into service initially or when putting back into service, it must be checked whether:

- All fastening screws (if existent), socket pins, flap socket and safety devices are tightened and secured.
- The oil levels in the gear boxes are sufficient.
- All movements of the load comply with the symbols on the control switch.

11 Functional test

11.1 Checks before initial start-up

Design

- Check all screws and safety connections
- The open-lying teeth of the crane trolley must be lubricated.

11.2 Functional test

Function - crane trolley

- Check properly running of the crane.
- Check the beam for obstacle-free running.
- Carefully move the crane to the end positions and check the positions of the end stops.
- Directions of movements must go conform to the symbols on the pendant control.



NOTE!

The limit switch function will only work if the movement direction of the load (lifting - lowering) corresponds to the push buttons of the control switch.

12 Maintenance

12.1 General

All monitoring, servicing and maintenance operations are to ensure correct functioning of the equipment; they must be effected with utmost care.

- Only “qualified persons” may do this work.
- Servicing and maintenance work must only be done when the hoist is not loaded.
- Records must be kept of all test results and measures taken.

12.2 Monitoring

The monitoring and servicing intervals stated are valid for operation under normal conditions and single-shift operation. In case of severe operating conditions (e.g. frequent operation with full load) or special environmental conditions (e.g., heat, dust, etc.), the intervals must be shortened correspondingly

12.3 Brake motor

Motor power kW	Brake Type	Brake V DC	Nom. brake torque Nm	Nom. air gap mm	Air gap max. mm	mm	
0,37	FDB 08	180	5	0,2	0,6	min. rotor thickness	4,5
0,55	FK	200	5	0,3	0,6	min. brake lining thickness	1
0,75	FDB 08	180	5	0,2	0,6	min. rotor thickness	4,5

12.3.1 Assembling the brake

- 1 Insert the retaining ring (1) into the shaft slot.
- 2 Insert the feather key (2) into the motor shaft.
- 3 Fix hub (3) with retaining ring (1).
- 4 Assemble the friction plate (4) if existent.
- 5 Push the rotor (5) onto the hub (3).
- 6 Lock the magnet body with the 3 fastening screws (6).
- 7 Set air gap “a” (refer to “adjusting the air gap”)
- 8 Assemble the dust-protection ring (7) if existent.
- 9 Electric connection

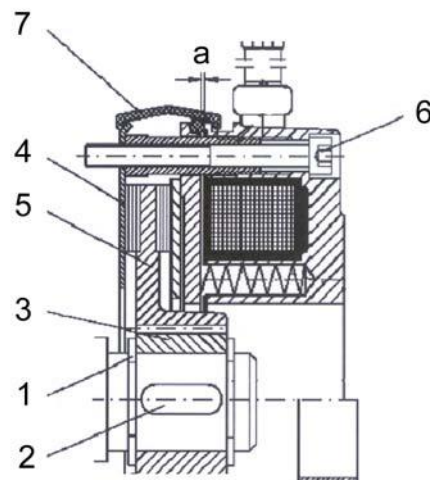

Illustration 15

12.3.2 Disassembly of the brake

Disassembly is performed in reverse order to the assembly.

12.3.3 Adjusting the air gap

View "X" on the brake.

- 1 Loosen the locking screws (6) by half a turn.
- 2 Turn the cap screws (8) into the magnetic body (9) anti-clockwise.
- 3 By turning the locking screws (6) clockwise, move the magnetic body (9) towards the anchor plate (10) using a feeler gauge until nominal air gap "a" is reached (see table).
- 4 Unscrew the cap screws (8) from the magnetic body clockwise.
- 5 Tighten the locking screws (6).
- 6 Check the air gap again and re-adjust if necessary.

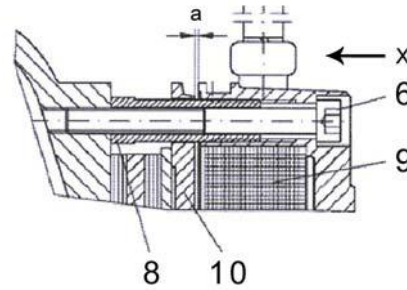

Illustration 16

13 Inspection

13.1 General Overhaul for motor-driven units

The accident prevention regulations VBG D8 must be observed and the measures to reach "safe working periods (S.W.P.)" according to FEM 9.755.

After the "theoretical working time D" has been elapsed, the owner/user must take motor driven devices out of operation and effect a General Overhaul.

Further use of the equipment is only allowed after a licensed qualified person has proofed

- that further use is possible without doubt

and

- the conditions for further use have been determined

These conditions have to be written down in the test book.

The owner/user is responsible to make sure that these conditions are observed.

13.2 Periodic checks

Independently from the regulations of the individual countries, HADEF lifting devices must be checked at least yearly by a qualified person or licensed qualified person regarding its functional safety.

In Germany it is necessary to observe the accident prevention regulations BGV D6, BGV D8, BGR 500 as well as DIN 15020 (Basics for cable drives). In other countries, the above mentioned tests and the national safety regulations apply.



13.3 Inspection intervals

	at putting into operation	daily checks	Inspection every 3 months	Inspection every 12 months
Check screw connections.	X			X
check socket pins and plugs	X			
Check the wheels for wear				X
Check the function of the brake (electric and pneumatic cranes)	X	X		
lubricate the teeth of the wheels			X	
Gear	see chapter "maintenance"			
inspection of the equipment by an expert (periodic inspection)				X

14 Service

14.1 Trolley

- Trolleys are lifetime lubricated, Refill lubricant is normally not necessary.
- Lubricate gear rim and pinion drive each ¼ year or if required more often, with grease.

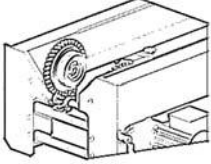
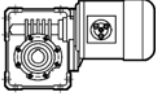
Use		Recommendation		Interval
Pulleys Gear rim Drive pinion		FUCHS RENOLIT FEP2	1 kg	3 month
Travelling gear If available		SHELL Tivela S320	---	Life time lubrication

14.2 Lubricant selection

FUCHS	SHELL	ESSO	ARAL	MOBIL	KLÜBER
Renolin PG 220	Tivela S 220	Glycolube 220	Degol GS 220	Glygoyle 30	Klubersynt GH 6-220
Renolin PG 320	Tivela S 320	Glygolube 320	Degol GS 320	Glygoyle 320	Klubersynt GH 6-320
Renolit FEP 2	Alvania EP 2	Unirex EP 2	--	Mobilux EP 2	--
Renolin B10 VG32	Tellus Oil 32	--	--	--	--

15 Trouble

Please pay attention to the following in case of problems:

- Troubles with the equipment must only be repaired by qualified personnel.
- Secure the unit against unintended operation start.
- Put up a warning note indicating that the unit is not to be used.
- Secure the working area of moving parts of the unit.
- Please read the chapter "Safety instructions".

Notes on the repair of faults are found in the following table.

For the repair of failures please contact our service department.



CAUTION!

Trouble caused by wear or damage to parts such as wire ropes, chains, chain wheels, axes, bearings, brake parts, etc., must be remedied by replacing the parts with original spare parts.

16 Remedy

Problem	Cause	Remedy
Trolley is hardly to travel	Obstacle on the beam Deformation in the construction	Remove the obstacle Examine the crane, have it repaired by an authorised workshop if necessary
Motor does not run	No mains voltage Fuse burnt out Defective switching unit in the push button Break in the control cable Brake does not release	Check the mains connection Replace the fuse Replace the switching unit see „problem brake does not release“
Motor hums and uses excessive current	Defective coil Rotor is rubbing Brake does not release	Motor must be repaired by a specialist See “problem brake does not release”
Damaged coil	mechanical or electrical overloading	Motor must be repaired by a specialist
Motor does not brake or has excessive after-running	brake linings are worn or oiled-up Air gap is too large Switching error after intervention in the electric circuit	Brake lining must be changed completely Re-adjust the air gap Check the electric connection of the brake acc. to the wiring diagram
Brake does not release	Brake rectifier defective Brake current relay defective Permissible air gap is exceeded due to worn out brake lining Power drop in the mains power line > 10%	Replace brake rectifier Replace brake current relay Re-adjust the air gap and exchange the brake lining if necessary Provide correct power supply voltage
Fuses bur out or motor contactor is triggered	Motor or wiring short-circuit Motor has a short-circuit in the body or windings Motor is wired incorrectly Wrong type of fuse	Correct the short-circuit Have the problem corrected by a specialist Correct the wiring Replace the fuse with correct one

17 Decommissioning



WARNING!

It is essential that the following points are observed in order to prevent damage to the equipment or critical injury when the device is being decommissioned:

It is mandatory that all steps for decommissioning the machine are carried out in the indicated sequence:

- First secure the working area for decommissioning, leaving plenty of space.
- Read the chapter "Safety instructions".
- Disassembly is carried out in reverse order to the assembly.
- Please make sure that all operating material is disposed of in accordance with environmental regulations.

17.1 Temporary decommissioning

- Measures are as above.
- Also read the chapter "Transport and storage".

17.2 Final decommissioning/disposal

- Measures are as above.
- After disassembly, ensure that the disposal of the equipment and any materials it contains is carried out in accordance with environmental regulations.

18 Additional documents

18.1 Electric wiring diagram

Wiring diagrams are attached to the consignment or included in the terminal box.
Except for units supplied without control.

18.2 Frequency converter

Separate operating instruction for frequency converter is included in the terminal box or is attached at the delivery.

18.3 Radio control

Should the unit be fitted with radio control, a manual for radio control is attached to the consignment.

18.4 Operating instruction for cranes

Acc. §§29-43 of accident prevention rules „Cranes“ BGV D6 is attached at the delivery.