



Installation,- Operating and Maintenance Instructions

HADEF Aluminium Spur Gear Hoist

Type 23/09

with monorail push travel trolley

HR

with monorail hand geared trolley

HH



HADEF

Internet Download: www.doc.hadef.de/b2309_gb.pdf

 **NOTICE!**

The installation or mounting instructions for incomplete machines you'll find in chapter "Installation"

© by Heinrich de Fries GmbH

Heinrich de Fries GmbH, Gauss Str. 20, D-40235 Düsseldorf

Heinrich De Fries GmbH will be named HADEF in the following text.
Original operating- and maintenance instructions in German language.
Translation in other languages is made of the German original.
A copy is available from HADEF on request.
Subject to changes.

Table of Contents

1	Information	4
2	Safety	5
2.1	Warning notice and symbols.....	5
2.2	Duty of care of the owner.....	5
2.3	Requirements for the operating personnel	6
2.4	Appropriate use	6
2.5	Basic safety measures	7
3	Transport and Storage	8
3.1	Transport.....	8
3.2	Safety device for transport	8
3.3	Storage	8
4	Description	9
4.1	Areas of application	9
4.2	Design.....	9
4.3	Functions.....	9
4.4	Important components.....	10
5	Technical data.....	11
6	Installation.....	12
6.1	Adjusting the gauge	12
6.2	Installation on the beam.....	12
6.3	Tools	13
7	Operation.....	14
8	Commissioning.....	15
8.1	General	15
8.2	Load chain.....	15

- 9 Safety check 16**
- 10 Functional test..... 17**
 - 10.1 Checks before the initial start-up..... 17
 - 10.2 Functional test..... 17
- 11 Maintenance..... 18**
 - 11.1 General 18
 - 11.2 Monitoring 18
 - 11.3 Replacing the load chain 18
- 12 Inspection 19**
 - 12.1 Periodic checks 19
 - 12.2 Checking the load chain 19
 - 12.3 Checking the load hook..... 20
 - 12.4 Checking - pawl 20
 - 12.5 Checking – Brake System 20
 - 12.6 Checking – Suspension and load hook bolt..... 20
- 13 Service..... 21**
 - 13.1 Load chain 21
 - 13.2 Load hook 21
 - 13.3 Gear 21
 - 13.4 Trolley..... 22
 - 13.5 Gear spring pressure brake 22
 - 13.6 Lubricant - Selection 22
 - 13.7 Lubricant for food industry – Selection (as option*)..... 22
- 14 Trouble 23**
- 15 Remedy 24**
- 16 Decommissioning 25**
 - 16.1 Temporary decommissioning 25
 - 16.2 Final decommissioning/disposal..... 25

1 Information

HADEF products meet European Union requirements, in particular the EU Machine Directive (2006/42/EG).

The entire company works acc. to a certified quality assurance system as per ISO 9001.

The production of components at HADEF is subject to strict, intermediate checks.

After assembly, each HADEF product is subject to a final test with overload.

For the operation of hoists, the accident prevention regulations BGV D8, BGV D6 and BGR 500 apply in Germany, amongst others.

The stated performance of the devices and meeting any warranty claims require adherence to all instructions in this manual.

Before delivery, all HADEF products are packed properly. Check the goods after receipt for any damage caused during transport. Report any damage immediately to the forwarding agent.

This manual allows a safe and efficient use of equipment. Images of this manual are for a principle understanding and can be different from the real design.

NOTICE!



We refer to the prescribed equipment tests before initial start-up, before putting back into operation and the regular periodic inspections.

In other countries any additional national regulations must be observed.

2 Safety

2.1 Warning notice and symbols

Warnings and notice are shown as follows in these instructions:

 DANGER!	This means that there is a high risk that leads, if it is not avoided, to death or severe injury.
 WARNING!	This means that there is a risk that could lead, if it is not avoided, to death or severe injury.
 CAUTION!	This means that there is little risk that could lead, if it is not avoided, to slight injury or damage to the device or its surrounding.



NOTICE!

Gives advice for use and other useful information.



Danger from electricity.



Danger from explosive area.

2.2 Duty of care of the owner

The unit was designed and built following a risk analysis and careful selection of the harmonized standards that are to be complied with, as well as other technical specifications. It therefore represents state-of-the-art technology and provides the highest degree of safety.

Our delivery includes the hoist supplied beginning at its suspension and ending at the load hook and if supplied with control, the control line/hose that leads to the hoist. Further operating material, tools, load attaching devices as well as main energy supply lines must be assembled according to the valid rules and regulations. For explosion-proof equipment, all these parts must be approved for use in area prone to explosion, or they must be suitable for use in area prone to explosion. The owner is responsible for this.

However, in everyday operation this degree of safety can only be achieved if all measures required are taken. It falls within the duty of care of the owner/user of the devices to plan these measures and to check that they are being complied with.

Complete the operating and installation instructions by any instructions (regarding supervision or notifications) that are important for the special kind of use of the equipment, i.e. regarding organization of work, work flow and human resources.

In particular, the owner/user must ensure that:

- The unit is only used appropriately.
- The device is only operated in a fault-free, fully functional condition, and the safety components, in particular, are checked regularly to ensure that it is functioning properly.
- The required personal protective equipment for the operators, service and repair personnel is available and is used.
- The operating instructions are always available at the location where the equipment is used and that they are legible and complete.
- The unit is only operated, serviced and repaired by qualified and authorized personnel.
- This personnel is regularly trained in all applicable matters regarding safety at work and environmental protection, and that they are familiar with the operating manual and, in particular, the safety instructions it contains.
- Any safety and warning signs on the devices are not removed and remain legible.
- Devices for use in area prone to explosion must (from customer's side) be earthed with a shunting resistor of $< 10^6 \Omega$ against earth.

 WARNING!
It is not allowed to make constructive changes of the equipment!

2.3 Requirements for the operating personnel

The units may only be operated by qualified persons that are appropriately trained and that are familiar with it. They must have their employer's authorisation for operation of the units.

Before starting work, the operating personnel must have read the operating and installation instructions, especially the chapter "Safety Instructions".

This is especially important for operating personnel that rarely uses the equipment, i.e. for installation or maintenance work.



DANGER!

In order to avoid severe injury, please pay attention to the following when using the equipment:

- Use protective clothes/equipment.
- Do not wear long hair hanging down open.
- Do not wear rings or other jewellery.
- Do not wear cloths that are too big/wide.

2.4 Appropriate use

The permitted safe working load of the devices must not be exceeded! An exception can be made during the load test, carried out by a licensed qualified person in accordance with the accident prevention regulations UVV BGV D6 before initial operation.

- The permitted environmental temperature during equipment operation is -20°C up to $+40^{\circ}\text{C}$!
- Defective devices and load suspension devices must not be used until they have been repaired! Only original HADEF spare parts must be used. Non-compliance will result in any warranty claims on HADEF becoming void.
- Liability and warranty will become void if unauthorized modifications of the units are made by the user!

The appropriate use of the hoists is vertical lifting and lowering of unguided loads. In combination with trolleys, loads can also be moved horizontally.



DANGER!

It is not allowed:

- pulling loose or stuck loads, dragging of loads and inclined pulling is not allowed.
- in explosive atmosphere, except the unit is especially modified for it and marked by an indication label
- to transport people
- persons must not stand under a suspended load



NOTICE!

If the units are not used appropriately, it is not possible to ensure safe operation.

The owner and operator have sole liability for all personal injury and damage to property arising from inappropriate use.

2.5 Basic safety measures

- Observe installation-, operation and maintenance instruction.
- Take notice of caution notes at units and in the manual
- Observe safety distances.
- Take care for a free view on the load.
- Only use the hoists appropriately.
- The equipment is to be used exclusively for movement of goods. Under no circumstances my persons be moved.
- Never load the devices beyond their working load limit.
- Pay attention to the accident prevention regulations (UVV).
- Should the hoist be used outside of Germany, please pay attention to the national regulations that apply.
- Supporting structures and load-attached devices used in conjunction with this equipment must provide an adequate safety factor to handle the rated load plus the weight of the equipment. In case of doubt, consult a structural engineer.
- If the equipment has not been used for a period of time, carry out visual checks of all main components such as chains, load hooks etc. and replace any damaged parts with new, original spare parts before putting the equipment back into operation!
- Do not use a hoist that is defective, pay attention to any abnormal noise it makes during operation.
- Stop working immediately in case of disturbances and remedy failures.
- Any damage and faults must be reported to a responsible supervisor immediately.
- If the unit is put into motion, any persons in the immediate vicinity must be informed by calling to them!
- Please pay attention to the regulations for load carrying devices UVV BGR500 for both positive and non-positive methods of attaching loads.
- The lifting tackle or the load must be securely attached to the hook and be seated at the bottom of the hook.
- The safety catch of hooks must be closed.
- When charged, the housing may not be in contact somewhere.
- Stop lowering the load when the bottom block or the load is being set down or is prevented from being lowered further.
- The load chain must not be twisted.
- Twisted chains must be aligned before attaching the load.
- The correct alignment of the chain links can be seen from the weld seams.
- The chain links must always be aligned in one direction.
- When charged, the housing may not be in contact somewhere.
- Motor drive is prohibited.
- The devices are not suitable for continuous operation. In order to avoid too high temperatures of the brake discs that are not permitted, the following maximum continuous operating times must not be exceeded:

▪ Light use (highest load is seldom lifted)	= 60 min
▪ Medium use (roughly equal frequency of light, medium and heavy loads)	= 30 min
▪ Heavy use (nearly always largest permissible load)	= 15 min

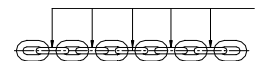

Illustration 1

Let the hoist stand still at least 15 minutes afterwards to cool down the brake.

WARNING!

The following is not allowed:

- to lift another load than the nominal safe working load
- to manipulate the sliding clutch if units are equipped with
- The use of elongated or damaged chains or wire ropes. Replace them immediately by new, original parts.
- Never loop the load chain around a load nor place or pull the chain over edges.
- Never repair damaged load hooks (e.g. by hammering), but replace them by original hooks.

3 Transport and Storage



CAUTION!

Transport may only be done by qualified personnel. No liability for any damage resulting from improper transport or improper storage.

3.1 Transport

HADEF devices are checked and if so adequately packed before delivery.

- Do not throw or drop the equipment.
- Use adequate means of transport.

Transport and means of transport must be suitable for the local conditions.

3.2 Safety device for transport



NOTICE!

Should a safety device for transport exist, please remove it before commissioning.

3.3 Storage

- Store the equipment at a clean and dry place.
- Protect the equipment against dirt, humidity and damage by an appropriate cover.
- Protect hooks, wire ropes, chains and brakes against corrosion.



4 Description

4.1 Areas of application

The devices must be as far as possible installed in a covered room.

If they are used in the open, protect the units against the effects of weather such as rain, hail, snow, direct sunshine, dust, etc. - we recommend to use a cover in parking position. If the device is set up in a continuously humid environment with strong temperature fluctuations, the correct functionings are endangered by the forming of condensation.

Ambient temperature: - 20°C up to + 40°C. Humidity: 100 % or less but not under water

	 DANGER!
It is not permitted to use the unit in an area at risk from explosion!	

4.2 Design

HADEF Spur Gear Hoists of compact design are monorail trolleys combined with manual hoists.

With monorail push travel trolley or
with monorail hand geared trolley

Operation by hand through hand chain.

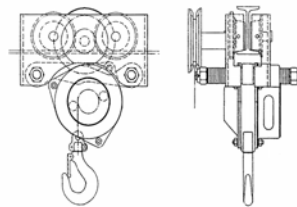

Illustration 2

4.3 Functions

The load is lifted or lowered by pulling one of the chain falls of the endless hand chain of the hoist. A load pressure brake prevents automatic lowering of the load after releasing the hand chain.

In combination with hand geared trolleys, the trolley is moved to the left or to the right side by pulling the hand chain.

In combination with push travel trolleys the trolley is moved by pushing or pulling the load or, without load, by pulling the load chain.

NOTICE!

The best protection against functional failures in case of extreme environmental impact is the regular use of the equipment.

4.4 Important components

4.4.1 Gear

Gear components are made of high-quality material.

4.4.2 Load pressure brake

Holds the load in any position. Hardened safety pawls.

4.4.3 Housing

Depending on the model made from steel plate or aluminium die-casting (Not for explosion proof equipment). In case of ex proof hoists, the housing is only made of steel plates.

4.4.4 Load chain

According to EN 818-7-T high quality chain. All components match precisely to each other. Therefore please only use original chains.

4.4.5 Load hook

Forged steel. Rotating, this facilitates attaching the load and avoids twisting of the chain. With safety catch.

4.4.6 Overload protection

Hoists with overload protection protects the hoist by a slipping clutch from damage by overload. When the slipping clutch operates, lifting of the load is stopped. Lifting is only possible again after the load has been lowered and reduced to nominal load.

5 Technical data

Type 23/09 HH

Capacity	t	0,5	1	1,5	2	3	5
Number of chain falls		1	1	1	2	2	3
Load chain	mm	5 x 15	6,3 x 19,1	8 x 24	6,3 x 19,1	8 x 24	8 x 24
Load bar size at beam flange width from - to 1N	mm	50-146	50-135	66-185	66-185	74-196	74-192
Load bar size at beam flange width from - to 2N	mm	147-302	136-220	186-310	186-310	197-310	193-310
Lifting path when reeling off 30 m of hand chain	mm	940	870	640	435	320	200
Hand chain pull for lifting	N	210	350	390	350	390	420
Travel path when reeling off 30 m of hand chain	m	7,8	10	9,8	9,8	6,3	6,3
Hand chain pull for travel	daN	6,5	10	11	15	11	17
weight at 3 m lift	approx. kg	21	27	46,5	45,5	74	89
weight per add. m lift	kg	2,5	2,8	3	3,7	4	5

Type 23/09 HR

Capacity	t	0,5	1	1,5	2	3	5
Number of chain falls		1	1	1	2	2	3
Load chain	mm	5 x 15	6,3 x 19,1	8 x 24	6,3 x 19,1	8 x 24	8 x 24
Load bar size at beam flange width from - to 1N	mm	50-146	50-135	66-185	66-185	74-196	74-192
Load bar size at beam flange width from - to 2N	mm	147-302	136-220	186-310	186-310	197-310	193-310
Lifting path when reeling off 30 m of hand chain	mm	940	870	640	435	320	200
Hand chain pull for lifting	N	210	350	390	350	390	420
weight at 3 m lift	approx. kg	19	25	44,5	41,5	71	86
weight per add. m lift	kg	2,4	2,7	2,8	3,5	3,8	4,8

6 Installation

6.1 Adjusting the gauge

The trolley can be adjusted to various beam flange widths. Adjustment to the relevant beam flange width "B" depends on the type and size and is to be made as follows:

- There are distance tubes (5) and/or washers (6) situated on the load bars (2) of the trolley.
- Dimension "X" is set by placing washers (6) from the outer to the inner side ("X" increases) or from the inner to the outer side ("X" decreases).
- Washers (6) and rubber discs (depended on type) leave a distance for the load hook. It is important that the load hangs in the middle under the beam so that the two side plates are equally loaded.
- The suspension eye (9) (if existent) for bigger load bolts must still be swivelling after it has been secured.
- Tighten the hexagon nut (3) and safety nuts (4) again.
- Check correct flange width "B" and dimension "X". Adjustment must be repeated if necessary.

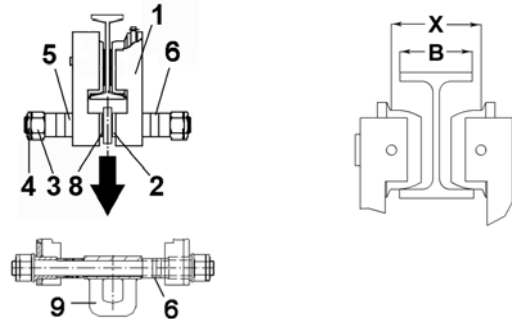

- 1 side plates
- 2 load bars
- 3 hexagon nut
- 4 safety nuts
- 5 distance tubes
- 6 washers
- 7 ---
- 8 rubber disc (depended on type)
- 9 suspension eye

6.2 Installation on the beam

- 1 Tighten the hexagon nut (3) and safety nuts (4).
- 2 Push on the trolley at the face of the beam flange.
- 3 If this is not possible, the trolley can also be mounted on the beam from below.
- 4 Therefore, remove the hexagon nut (3) and the safety nut (4) on the side without gear.
- 5 Pull apart the side plates (1) as far until it is possible to push the trolley onto the beam flange from below. Afterwards, push the trolley together to correct gauge.
- 6 Secure the washers (6) and distance tubes (5) by tightening the hexagon nuts (3) and the safety nuts (4).

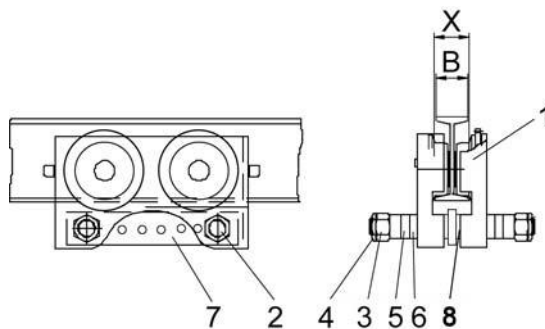
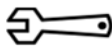
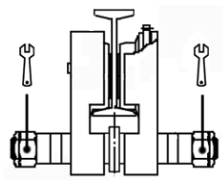
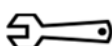
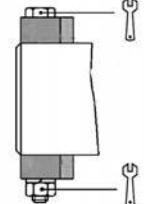

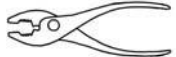



Illustration 3

CAUTION!

The distance "X" between the wheel flanges of the trolley wheels must be for trolleys up to 3,2 t: 2-3 mm (1-1,5 mm each side) bigger and for trolleys from 4 t up: 3-5 mm (1,5-2,5 mm each side) bigger than the flange width "B" of the beam

6.3 Tools

Capacity	Size	Tool	Use	
0,5t 1t to 2t to 3,2t to 6,3t to 10t	SW27 SW36 SW46 SW55 SW60 SW75		Load bar	
12,5t to 60t	SW22 SW24		Load bar with fixing ring	
			diff.	
			diff.	
	diff.		diff.	

7 Operation

Only people that are familiar with the operation of the lifting devices and cranes may be entrusted with their operation. They must be authorized by the employer for the operation of the equipment. The employer must ensure that the operating instructions are available near the equipment and that they are accessible for the operating personnel.

Lifting and Lowering by pulling the endless hand chain.

Lifting - pull the chain fall at the right side –
the hand chain wheel turns clockwise

Lowering - pull the chain fall at the lift side –
the hand chain wheel turns anti-clockwise

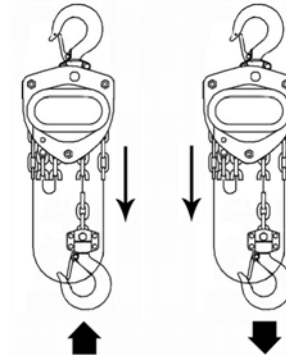

Illustration4

Monorail push travel trolleys are moved by pushing the load.

Monorail hand geared trolleys are moved by pulling the hand chain.



WARNING!

The hoist must always hang centrally under the beam or under its suspension point.

8 Commissioning

8.1 General

Should the unit be used in Germany, please observe the accident prevention regulations, in particular BGV D8, BGV D 6 and BGR 500 (VBG 9a).

For other countries: Inspections as above. Please observe the national rules and regulations and the instructions in this manual!

NOTICE!

Hoists up to 1000 kg capacity and without motor-driven trolleys of hoisting unit must be tested by a “qualified person” before putting into operation for the first time.

Hoists of 1000 kg capacity and up or with more than one motor-driven hoist movement; i.e. lifting and trolley movement, must be tested by a “licensed qualified person” before putting in operation.

An exception is “hoists ready for operation” acc. To BGV D6 II§25(4) with EU-declaration of conformity.

Definition “qualified person” (former expert)

A “qualified person” has learned, due to occupational training and experience and the job that the person has done, the skills needed to tests the material for one’s work.

Definition “licensed qualified person” (former approved expert)

A “licensed qualified person” has, due through special occupational training, knowledge about testing of the material for one’s work and knows the national accident prevention regulations and other prescriptions and technical regulations. This person must test the material for one’s work regularly with regard to design and kind of use. The license will be given to qualified person be the approved supervision authorities (ZÜS).

8.2 Load chain

- Before commissioning the load chain must be aligned and oiled.
- Move safety note and fixing wire away from the chain.

CAUTION!

Do not use grease for lubrication of load chain.

Without lubrication, manufacturer's warranty and/or liability will be void.

NOTICE!

Continuous, thorough lubrication will increase the life of the chain considerably.

9 Safety check

Before putting into service initially or when putting back into service, it must be checked whether:

- All fastening screws (if existent), socket pins, flap socket and safety devices are tightened and secured.
- The chains are correctly placed, oiled and in good condition.

10 Functional test

10.1 Checks before the initial start-up

Lifting gear

- Load chains must not be twisted.
- Lubricate the load chain with gear oil or suitable chain lubricant before first loading.

Trolley drive

- The open-lying teeth of the trolley drive must be lubricated.

Hand gear for hand geared trolley

- Ensure correct fit of the hand chain, it must not be twisted and must hang freely.

10.2 Functional test

Lifting gear

Check lifting and lowering functions, initially without a load.

Then check the brake function under load. The load must be securely held.

Trolleys

Carefully move the trolley to the end positions and check the positions of the end stops.

11 Maintenance

11.1 General

All monitoring, servicing and maintenance operations are to ensure correct functioning of the equipment; they must be effected with utmost care.

- Only “qualified persons” may do this work.
- Servicing and maintenance work must only be done when the hoist is not loaded.
- Records must be kept of all test results and measures taken.

11.2 Monitoring

The monitoring and servicing intervals stated are valid for operation under normal conditions and single-shift operation. In case of severe operating conditions (e.g. frequent operation with full load) or special environmental conditions (e.g., heat, dust, etc.), the intervals must be shortened correspondingly

11.3 Replacing the load chain



CAUTION!

If there is any visible damage and when the conditions for replacement are reached (i.e. one or several dimensions in the table have been reached, there is corrosion or elongation), the chain must be replaced.

When replacing the chain, also check the chain wheels.

Procedure:

- Only insert new chains in an unloaded state and as the chains that are currently in the device – i.e. not twisted.
- Remove chain from its fastening at the end and attach a chain link which is open at the side.
- A chain link which is open at the side, can easily be produced by grinding out a small piece. The opening must have the same thickness as the chain link.

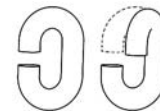

Illustration 5

- Hang a new original chain (same size and oiled) in the side opened chain link and insert it.
- Make sure the chain is not installed twisted.
- Make sure the chain links are aligned in one direction.
- Assemble the chain to the end fastening.

12 Inspection

12.1 Periodic checks

Independently from the regulations of the individual countries, HADEF lifting devices must be checked at least yearly by a qualified person or licensed qualified person regarding its functional safety.

In Germany it is necessary to observe the accident prevention regulations BGV D6, BGV D8, BGR 500 as well as DIN 15020 (Basics for cable drives). In other countries, the above mentioned tests and the national safety regulations apply.

12.1.1 Components to be checked

The following must be checked:

- Dimensions of load chain, load hooks, pawls, bolts, ratchet wheels, brake linings.
The dimensions must be compared to the dimensions in the tables.
- A visual inspection for deformations, cracks and corrosion must be carried out.

	on commissioning	daily checks	1st maintenance after 3 months	Inspection Maintenance every 3 months	Inspection Maintenance every 12 months
Check screw connections	X				X
Check lifting, lowering functions.	X	X			
Check brake function	X	X			
Check free-wheeling of chain (only applicable for ratchet lever hoists with free-wheeling mechanism)	X	X			
Brake - check the brake disc thickness					X
Check sprocket wheels, ratchet wheels, pawls, bolts					X
Clean and lubricate the load chain	X		X	X	
Check the load chain for elongation and wear					X
Check the load hook for cracks and deformation					X
Load hook - check the safety latch	X	X			
Check and lubricate the bearing of the chain pulleys			X		X
Check the chain pulleys			X	X	
Check the rubber end stops	X		X		X
Check the trolley wheels for wear					X
Check lubrication of the trolley driving pinion	X		X		X
Have the equipment checked by a qualified person (periodic inspection)					X

WARNING!

If one or several of the dimensions fall below or exceed the dimensions in the table, or if cracks or corrosion are found, the parts must be replaced with original spare parts.

12.2 Checking the load chain

acc. DIN 685-part 5

L11 = pitch increase over 11 chain links

L1 = pitch increase over 1 chain link

dm = detected link thickness

Chain dimensions

Dimensions mm	Chain size		
	5x15	6,3x19,1	8x24
L11	170,6	216,6	272,1
L1	15,7	20,1	25,3
dm	4,5	5,7	7,2

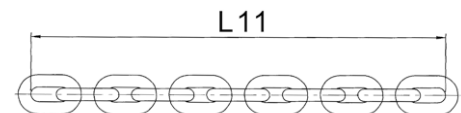

Illustration 6

WARNING!

When the dimensions listed in the table are reached due to wear or deformation, the chain must be replaced!

12.3 Checking the load hook

Load hook

X = measuring distance hook mouth width
 Y = measured length from hook no. 6
 H = thickness of hook saddle

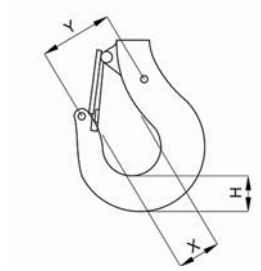

Illustration 7

Table 1

Dimensions mm	Capacity/chain falls						
	0,25/1	0,5/1	1/1	1,5/1	2/2	3/2	5/2
X or Y	28/38,4	28/38,4	32/43,4	36/48,9	40/55,4	44/63,6	50/74,8
H	19,3	19,3	25,1	28,8	33,4	39,2	44,5

Dimensions in the tables are theoretical values without tolerances.

Please fill in the measured values before commissioning:

Capacity	t
X or Y	mm
H	mm

CAUTION!

When the dimension of hook opening width is deformed more than 10% or when the dimension of the hook bottom thickness is fallen short of by 5% due to wear, the hook must be replaced.

12.4 Checking - pawl

kg	A	V _{min}
	mm	mm
250+500	23,7	22,52
1000+2000	25	23,75
1500+3000+5000	30	28,5

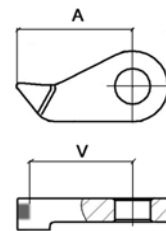

12.5 Checking – Brake System

Ratchet wheel (A) and brake linings (B)

kg	D	V _{min}	t _n	t _{vmin}
	mm	mm	mm	mm
250+500	60	58,5	1,5	1,2
1000+2000	72	70,56	1,5	1,2
1500+3000+5000	80	78,4	1,5	1,2

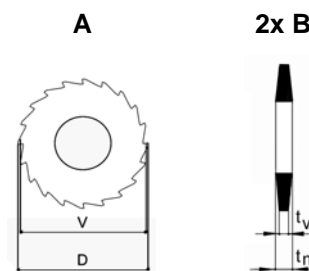

12.6 Checking – Suspension and load hook bolt

kg	Suspension bolt		Load hook bolt	
	dn	dv _{min}	dn	dv _{min}
	mm	mm	mm	mm
250+500	12	10,8	6	5,4
1000	14	12,6	7,5	6,75
1500	14	12,6	18,7	16,83
2000	15,5	13,95	16	14,4
3000	14	12,6	22	20,9
5000	22,2	21,09	22,2	21,09



13 Service

13.1 Load chain

Wear at the links is mainly due to insufficient maintenance of the chain.



To ensure optimal lubrication of the links, the chain must be lubricated at regular intervals, depending on usage.

- When lubricating with suitable oil that creeps, the load must be taken off the chain so that the oil can wet the links affected by wear.
- It is not sufficient to lubricate the chain from the outside, as this will not ensure the formation of a lubricating film within the links.
- If the same lifting operations are carried out constantly, the switching area from a lifting to a lowering movement must be given special attention.
- Thoroughly effected lubrication of the chain will prolong the life of the chain by approx. 20 times, compared to dry run with unlubricated chain.
- Wash dirty chain with petroleum or a similar cleaner, under no circumstances heat the chain.
- Always lubricate the chain when it is not under load. The adjacent link points must always be lubricated to prevent excessive wear.
- Lubricate the chain with a lubricant that creeps, e.g. automotive gear oil.
- If there are environmental influences that foster wear, such as sand, a dry lubricant should be used, e.g. graphite powder.
- When lubricating the chain's condition of wear should be checked.

Use		Recommendation		Interval
Load chain		Gear oil for example: FUCHS RENOLIN PG 220 or special chain lubricant Use NO grease!	0,2 l	3 month

13.2 Load hook

- Check bearings and pulleys yearly
- Clean and lubricate the bearings of hooks and pulleys with grease
- Slight bearings are maintenance free
- When bearings resp. slight bearings are worn of, change the complete pulley



Use		Recommendation		Interval
Load hook bearing		FUCHS RENOLIT FEP2	0,1 kg	12 month

13.3 Gear

Regular checks of lubrication are necessary. The teeth must be cleaned and re-lubricated after approx. 3 years. We recommend to use a lubricant of class EP2 or similar products. In case of severe conditions of use (e.g. dust, regular lifting of the nominal load, etc.), please shorten maintenance intervals.

13.4 Trolley

- Trolleys are lifetime lubricated, Refill lubricant is normally not necessary.
- Lubricate gear rim and pinion drive each ¼ year or if required more often, with grease.

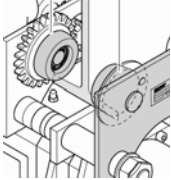
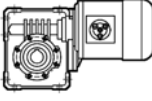
Use		Recommendation		Interval
Pulleys Gear rim Drive pinion		FUCHS RENOLIT FEP2	0,5 kg	3 month
Travelling gear If available		SHELL Tivela S320	---	Life time lubrication

13.5 Gear spring pressure brake

During the check, brake lining wear is verified. The brake linings must be replaced when the wear limit is already reached at one position of the lining, - as this can be the case when wear of the linings is irregular.

 **CAUTION!**
The brake linings must be free from fracture. Avoid oil, grease, dirt and humidity on the brake linings as this increases wear.

13.6 Lubricant - Selection

FUCHS	SHELL	ESSO	MOBIL	TOTAL	CASTROL	KLÜBER
Renolit FEP 2	Alvania EP 2	Unirex EP 2	Mobilux EP 2	MULTIS EP2	--	--
Stabylan 5006	--	--	--	--	Optimol Viscoleb 1500	Klüberoil 4UH 1-1500

13.7 Lubricant for food industry – Selection (as option*)

	SHELL	MOBIL	CASTROL
Gearing	FM Grease HD2	Mobilegrease FM 222	--
Load chain	--	Lubricant FM 100	Optimol Viscoleb 1500
Load hook Pulleys Gear rim Drive pinion	FM Grease HD2	Mobilegrease FM 222	--

* must be mentioned by order

14 Trouble

Please pay attention to the following in case of problems:

- Troubles with the equipment must only be repaired by qualified personnel.
- Secure the unit against unintended operation start.
- Put up a warning note indicating that the unit is not to be used.
- Secure the working area of moving parts of the unit.
- Please read the chapter "Safety instructions".

Notes on the repair of faults are found in the following table.

For the repair of failures please contact our service department.



CAUTION!

Trouble caused by wear or damage to parts such as wire ropes, chains, chain wheels, axes, bearings, brake parts, etc., must be remedied by replacing the parts with original spare parts.

15 Remedy

Problem	Cause	Remedy
Load is not lifted	Overload	reduce the load to nominal load
	load got stuck	set the load free again
	brake linings are worn	Do maintenance and exchange the brake linings
	Load chain is twisted	Align the load chain
	Defect of chain, gear or chain wheels	Do maintenance and replace defective parts by original spare parts
	Pawl does not engage properly	Check the pawl and replace it if necessary
	Pawl spring is missing	Do maintenance and replace defective parts by original spare parts
It is difficult to lift the load	Overload	reduce the load to nominal load
	Dirty chains, gear or chain wheels	Do maintenance, lubricate chains, gear and chain wheels
	Defect of chain, gear or chain wheels	Do maintenance and replace defective parts by original spare parts
Load is lifted with interruptions	Pawl spring is missing or defective	Do maintenance and replace defective parts by original spare parts
Hoist does not lift without load	Brake spring is missing	Do maintenance and replace defective parts by original spare parts
Hoist does not lift the whole distance long	Hook stuck, chain is twisted	Place hooks and chains in correct position
Brake remains closed (stuck)	The load hook was pulled against the housing and got stuck there.	Release the hook, suspend the load again, lower the load, unload the hoist.
Hoist does not lower the load	Brake too tight	Lift the brake.
	Brake too tight due to rust	Replace rusty parts and effect periodic inspection
Load slips down partially during lowering	Foreign-object between the brake discs	Remove the foreign-object, clean the surface Should the surface show lines, replace the brake disc
Load slips down during lowering	Brake discs are missing, are installed incorrectly or are worn	Replace the brake discs resp. install them correctly

16 Decommissioning



WARNING!

It is essential that the following points are observed in order to prevent damage to the equipment or critical injury when the device is being decommissioned:

It is mandatory that all steps for decommissioning the machine are carried out in the indicated sequence:

- First secure the working area for decommissioning, leaving plenty of space.
- Read the chapter "Safety instructions".
- Disassembly is carried out in reverse order to the assembly.
- Please make sure that all operating material is disposed of in accordance with environmental regulations.

16.1 Temporary decommissioning

- Measures are as above.
- Also read the chapter "Transport and storage".

16.2 Final decommissioning/disposal

- Measures are as above.
- After disassembly, ensure that the disposal of the equipment and any materials it contains is carried out in accordance with environmental regulations.